



Description

The HSU55N02 is the high cell density trenched N-ch MOSFETs, which provide excellent RDSON and gate charge for most of the synchronous buck converter applications.

The HSU55N02 meet the RoHS and Green Product requirement, 100% EAS guaranteed with full function reliability approved.

- 100% EAS Guaranteed
- Green Device Available
- Super Low Gate Charge
- Battery protection
- Power management

Product Summary

V_{DS}	20	V
$R_{DS(ON),typ}$	5.3	m Ω
I_D	55	A

TO-252 Pin Configuration

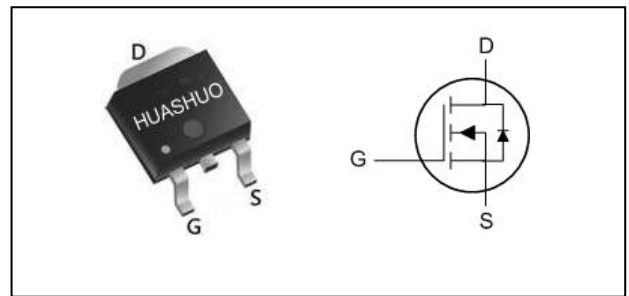

Absolute Maximum Ratings

Symbol	Parameter	Rating	Units
V_{DS}	Drain-Source Voltage	20	V
V_{GS}	Gate-Source Voltage	± 12	V
$I_D@T_C=25^\circ C$	Continuous Drain Current, $V_{GS} @ 10V^1$	55	A
$I_D@T_C=100^\circ C$	Continuous Drain Current, $V_{GS} @ 10V^1$	40	A
I_{DM}	Pulsed Drain Current ²	220	A
EAS	Single Pulse Avalanche Energy ³	135	mJ
$P_D@T_C=25^\circ C$	Total Power Dissipation ⁴	29	W
T_{STG}	Storage Temperature Range	-55 to 150	$^\circ C$
T_J	Operating Junction Temperature Range	-55 to 150	$^\circ C$

Thermal Data

Symbol	Parameter	Typ.	Max.	Unit
$R_{\theta JA}$	Thermal Resistance Junction-ambient (Steady State) ¹	---	62	$^\circ C/W$
$R_{\theta JC}$	Thermal Resistance Junction-Case ¹	---	4.0	$^\circ C/W$



Electrical Characteristics (T_J=25 °C, unless otherwise noted)

Symbol	Parameter	Conditions	Min.	Typ.	Max.	Unit
BV _{DSS}	Drain-Source Breakdown Voltage	V _{GS} =0V, I _D =250uA	20	---	---	V
ΔBV _{DSS} /ΔT _J	BVDSS Temperature Coefficient	Reference to 25°C, I _D =1mA	---	0.028	---	V/°C
R _{DS(ON)}	Static Drain-Source On-Resistance ²	V _{GS} =4.5V, I _D =20A	---	5.3	7.0	mΩ
		V _{GS} =2.5V, I _D =15A	---	6.5	8.6	
V _{GS(th)}	Gate Threshold Voltage	V _{GS} =V _{DS} , I _D =250uA	0.5	---	0.9	V
ΔV _{GS(th)}	V _{GS(th)} Temperature Coefficient		---	-6.16	---	mV/°C
I _{DSS}	Drain-Source Leakage Current	V _{DS} =20V, V _{GS} =0V, T _J =25°C	---	---	1	uA
		V _{DS} =20V, V _{GS} =0V, T _J =55°C	---	---	5	
I _{GSS}	Gate-Source Leakage Current	V _{GS} = ± 12V, V _{DS} =0V	---	---	± 100	nA
g _{fs}	Forward Transconductance	V _{DS} =10V, I _D =20A	10	---	---	S
R _g	Gate Resistance	V _{DS} =0V, V _{GS} =0V, f=1MHz	---	1.2	---	Ω
Q _g	Total Gate Charge (4.5V)	V _{DS} =20V, V _{GS} =10V, I _D =20A	---	23	---	nC
Q _{gs}	Gate-Source Charge		---	4.5	---	
Q _{gd}	Gate-Drain Charge		---	7.5	---	
T _{d(on)}	Turn-On Delay Time	V _{DD} =10V, V _{GS} =4.5V, R _G =3.3Ω I _D =15A	---	15	---	ns
T _r	Rise Time		---	33	---	
T _{d(off)}	Turn-Off Delay Time		---	44	---	
T _f	Fall Time		---	95	---	
C _{iss}	Input Capacitance	V _{DS} =10V, V _{GS} =0V, f=1MHz	---	2250	---	pF
C _{oss}	Output Capacitance		---	200	---	
C _{rss}	Reverse Transfer Capacitance		---	125	---	

Diode Characteristics

Symbol	Parameter	Conditions	Min.	Typ.	Max.	Unit
I _S	Continuous Source Current ^{1,5}	V _G =V _D =0V, Force Current	---	---	55	A
I _{SM}	Pulsed Source Current ^{2,5}		---	---	220	A
V _{SD}	Diode Forward Voltage ²	V _{GS} =0V, I _S =20A, T _J =25°C	---	---	1.0	V
t _{rr}	Reverse Recovery Time	I _F =20A, dI/dt=100A/μs, T _J =25°C	---	12	---	nS
Q _{rr}	Reverse Recovery Charge		---	2.6	---	nC

Note :

- 1.The data tested by surface mounted on a 1 inch² FR-4 board with 20Z copper.
- 2.The data tested by pulsed, pulse width ≤ 300us, duty cycle ≤ 2%
- 3.The EAS data shows Max. rating. The test condition is V_{DD}=10V, V_{GS}=10V, L=0.5mH
- 4.The power dissipation is limited by 175°C junction temperature
- 5.The data is theoretically the same as I_D and I_{DM}, in real applications, should be limited by total power dissipation.



Typical Characteristics

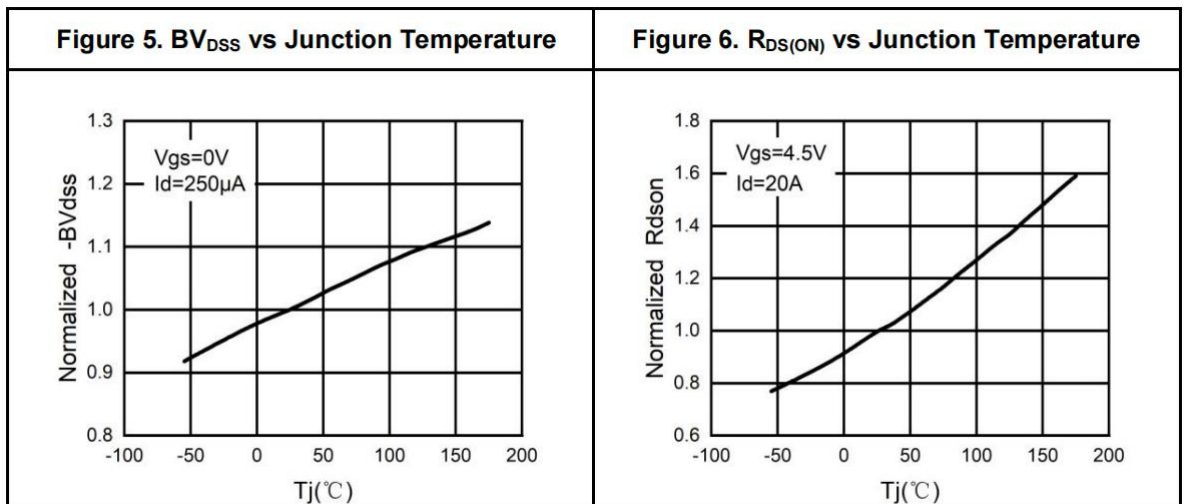
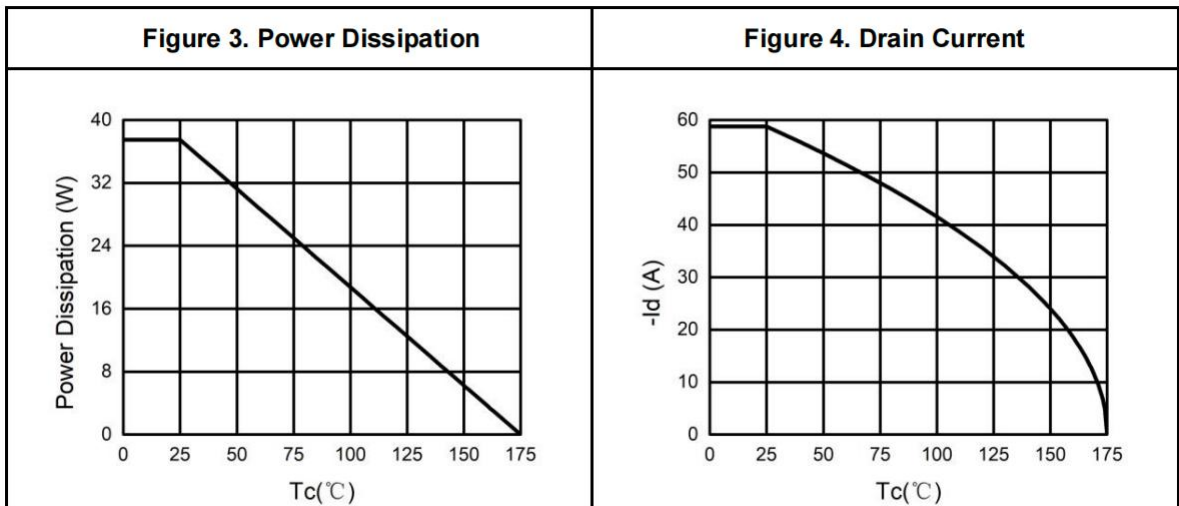
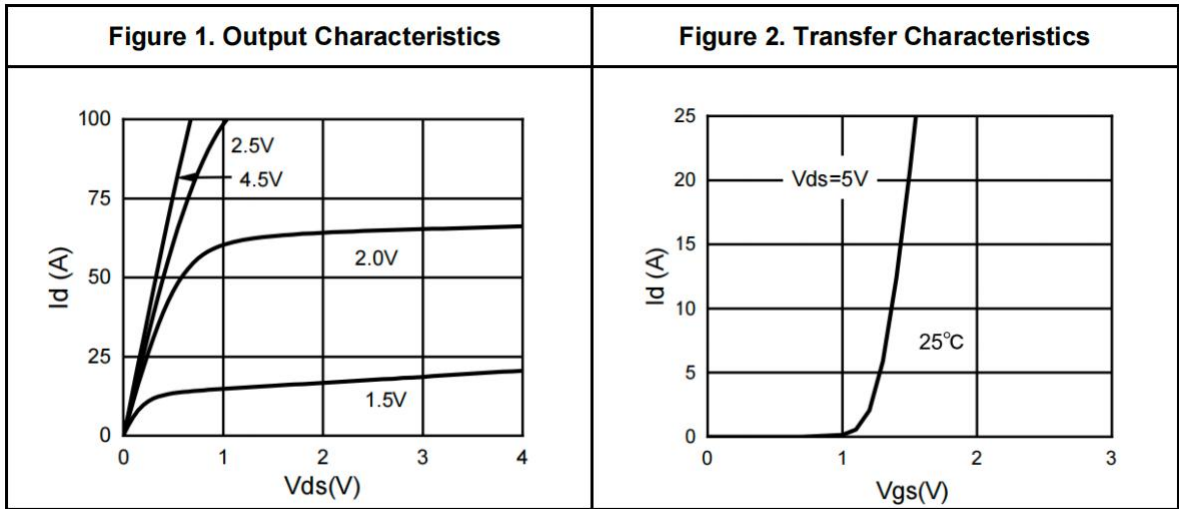



Figure 7. Gate Charge Waveforms

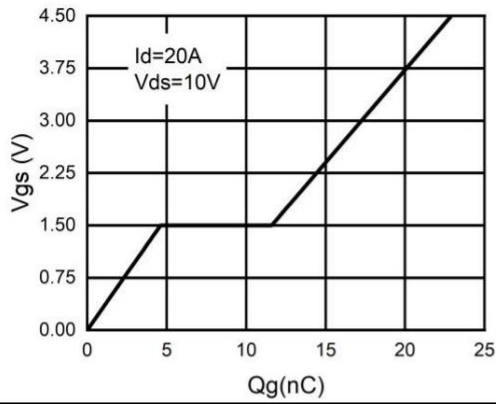

Figure 8. Capacitance

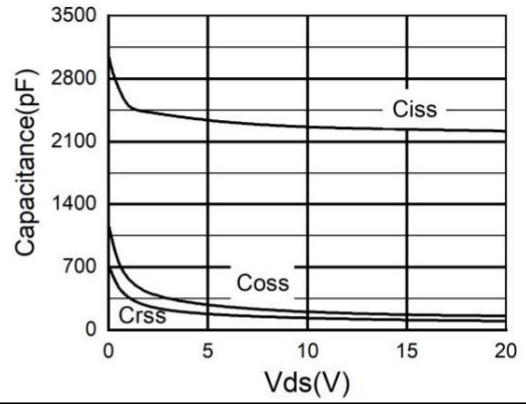

Figure 9. Body-Diode Characteristics

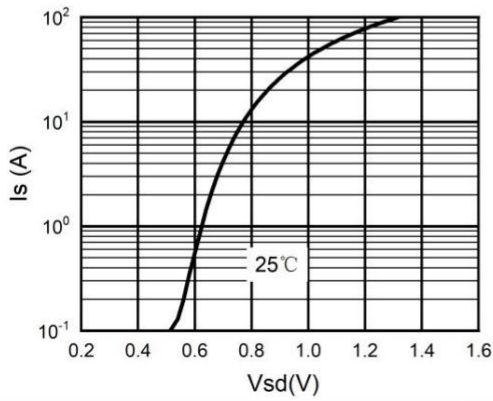
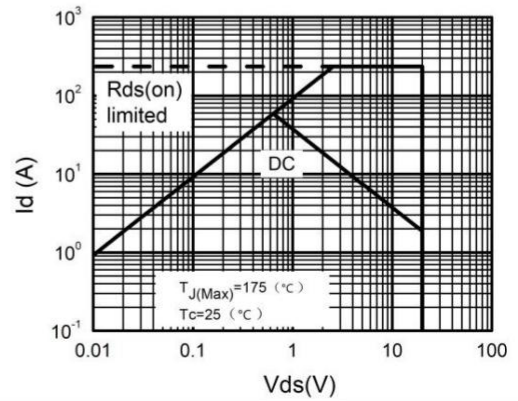
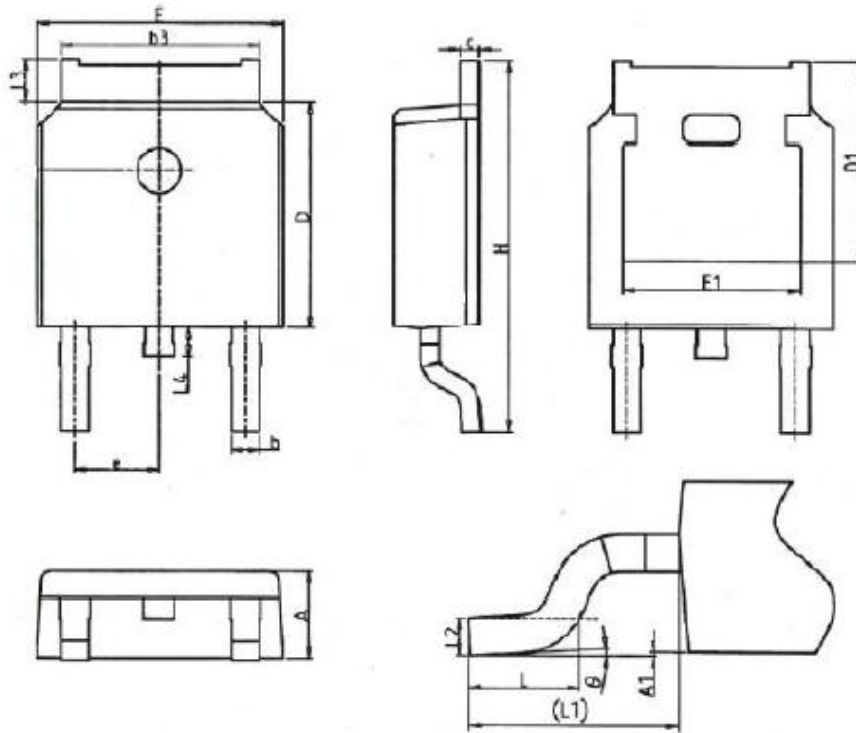

Figure 10. Maximum Safe Operating Area





TO252-2L Package Outline



SYMBOLS	MILLIMETERS		INCHES	
	MIN	MAX	MIN	MAX
A	2.18	2.40	0.086	0.095
A1	-	0.2	-	0.008
b	0.68	0.9	0.026	0.036
b3	4.95	5.46	0.194	0.215
c	0.43	0.89	0.017	0.035
D	5.97	6.22	0.235	0.245
D1	5.300REF		0.209REF	
E	6.35	6.73	0.250	0.265
E1	4.32	--	0.170	-
e	2.286BSC		0.09BSC	
H	9.4	10.5	0.370	0.413
L	1.38	1.78	0.054	0.070
L1	2.90REF		0.114REF	
L2	0.51BSC		0.020BSC	
L3	0.88	1.28	0.034	0.050
L4	0.5	1	0.019	0.039
θ	0°	8°	0°	8°