

**N-Ch 200V Fast Switching MOSFETs**
**Description**

The HSL03N20 is the high cell density trench N-ch MOSFETs, which provides excellent RDSON and efficiency for most of the small power switching and load switch applications.

The HSL03N20 meets the RoHS and Green Product requirement with full function reliability approved.

- Green Device Available
- Super Low Gate Charge
- Excellent Cdv/dt effect decline
- Advanced high cell density Trench technology

**Product Summary**

|                  |     |          |
|------------------|-----|----------|
| $V_{DS}$         | 200 | V        |
| $R_{DS(ON),typ}$ | 0.6 | $\Omega$ |
| $I_D$            | 1.5 | A        |

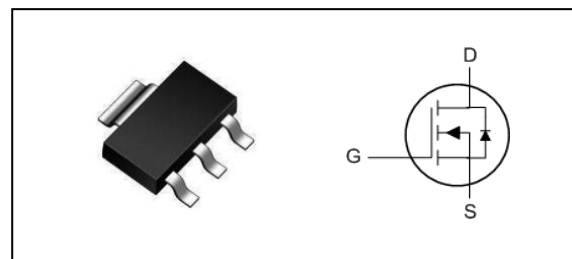
**SOT223 Pin Configuration**

**Absolute Maximum Ratings**

| Symbol               | Parameter                                  | Rating     | Units      |
|----------------------|--|------------|------------|
| $V_{DS}$             | Drain-Source Voltage                       | 200        | V          |
| $V_{GS}$             | Gate-Source Voltage                        | $\pm 20$   | V          |
| $I_D@T_A=25^\circ C$ | Continuous Drain Current, $V_{GS} @ 10V_1$ | 1.5        | A          |
| $I_D@T_A=70^\circ C$ | Continuous Drain Current, $V_{GS} @ 10V_1$ | 1.3        | A          |
| $I_{DM}$             | Pulsed Drain Current <sub>2</sub>          | 8          | A          |
| $P_D@T_A=25^\circ C$ | Total Power Dissipation <sub>3</sub>       | 42         | W          |
| $T_{STG}$            | Storage Temperature Range                  | -55 to 150 | $^\circ C$ |
| $T_J$                | Operating Junction Temperature Range       | -55 to 150 | $^\circ C$ |

**Thermal Data**

| Symbol          | Parameter  | Typ. | Max. | Unit         |
|-----------------|--|------|------|--------------|
| $R_{\theta JA}$ | Thermal Resistance Junction-ambient <sub>1</sub> | ---  | 85   | $^\circ C/W$ |
| $R_{\theta JC}$ | Thermal Resistance Junction-Case <sub>1</sub>    | ---  | 30   | $^\circ C/W$ |

**N-Ch 200V Fast Switching MOSFETs**
**Electrical Characteristics (T<sub>J</sub>=25 °C, unless otherwise noted)**

| Symbol              | Parameter                                      | Conditions  | Min. | Typ. | Max. | Unit |
|---------------------|--|---|------|------|------|------|
| B <sub>VDS</sub>    | Drain-Source Breakdown Voltage                 | V <sub>GS</sub> =0V, I <sub>D</sub> =250uA  | 200  | ---  | ---  | V    |
| R <sub>DS(on)</sub> | Static Drain-Source On-Resistance <sup>2</sup> | V <sub>GS</sub> =10V, I <sub>D</sub> =1A  | ---  | 0.6  | 1.0  | Ω    |
|                     |  | V <sub>GS</sub> =4.5V, I <sub>D</sub> =1A   | ---  | 0.7  | 1.1  | Ω    |
| V <sub>GS(th)</sub> | Gate Threshold Voltage                         | V <sub>GS</sub> =V <sub>DS</sub> , I <sub>D</sub> =250uA                              | 1.2  | 2    | 3    | V    |
| I <sub>DSS</sub>    | Drain-Source Leakage Current                   | V <sub>DS</sub> =200V, V <sub>GS</sub> =0V, T <sub>J</sub> =25°C                      | ---  | ---  | 1    | uA   |
|                     |  | V <sub>DS</sub> =200V, V <sub>GS</sub> =0V, T <sub>J</sub> =55°C                      | ---  | ---  | 5    |      |
| I <sub>GSS</sub>    | Gate-Source Leakage Current                    | V <sub>GS</sub> =±20V, V <sub>DS</sub> =0V  | ---  | ---  | ±100 | nA   |
| g <sub>fs</sub>     | Forward Transconductance                       | V <sub>DS</sub> =10V, I <sub>D</sub> =1A  | ---  | 10   | ---  | S    |
| Q <sub>g</sub>      | Total Gate Charge (10V)                        | V <sub>DS</sub> =160V, V <sub>GS</sub> =10V, I <sub>D</sub> =1A                       | ---  | 15   | ---  | nC   |
| Q <sub>gs</sub>     | Gate-Source Charge                             |   | ---  | 2.9  | ---  |      |
| Q <sub>gd</sub>     | Gate-Drain Charge                              |   | ---  | 5    | ---  |      |
| T <sub>d(on)</sub>  | Turn-On Delay Time                             | V <sub>DD</sub> =100V, V <sub>GS</sub> =10V, R <sub>G</sub> =3Ω<br>I <sub>D</sub> =1A | ---  | 22   | ---  | ns   |
| T <sub>r</sub>      | Rise Time                                      |   | ---  | 30   | ---  |      |
| T <sub>d(off)</sub> | Turn-Off Delay Time                            |   | ---  | 44   | ---  |      |
| T <sub>f</sub>      | Fall Time                                      |   | ---  | 12   | ---  |      |
| C <sub>iss</sub>    | Input Capacitance                              | V <sub>DS</sub> =25V, V <sub>GS</sub> =0V, f=1MHz                                     | ---  | 900  | ---  | pF   |
| C <sub>oss</sub>    | Output Capacitance                             |   | ---  | 125  | ---  |      |
| C <sub>rss</sub>    | Reverse Transfer Capacitance                   |   | ---  | 4.5  | ---  |      |

**Diode Characteristics**

| Symbol          | Parameter                                | Conditions  | Min. | Typ. | Max. | Unit |
|-----------------|--|---|------|------|------|------|
| I <sub>S</sub>  | Continuous Source Current <sup>1,4</sup> | V <sub>G</sub> =V <sub>D</sub> =0V, Force Current             | ---  | ---  | 1    | A    |
| V <sub>SD</sub> | Diode Forward Voltage <sup>2</sup>       | V <sub>GS</sub> =0V, I <sub>S</sub> =1A, T <sub>J</sub> =25°C | ---  | ---  | 1    | V    |
| t <sub>rr</sub> | Reverse Recovery Time                    | I <sub>F</sub> =1A, dI/dt=100A/μs, T <sub>J</sub> =25°C       | ---  | 85   | ---  | nS   |
| Q <sub>rr</sub> | Reverse Recovery Charge                  |   | ---  | 250  | ---  | nC   |

**Note:**

1. The data tested by surface mounted on a 1 inch<sup>2</sup> FR-4 board with 2OZ copper.
2. The data tested by pulsed, pulse width ≤ 300us, duty cycle ≤ 2%
3. The power dissipation is limited by 150°C junction temperature
4. The data is theoretically the same as I<sub>D</sub> and I<sub>DM</sub>, in real applications, should be limited by total power dissipation.

**N-Ch 200V Fast Switching MOSFETs**

**Typical Characteristics**

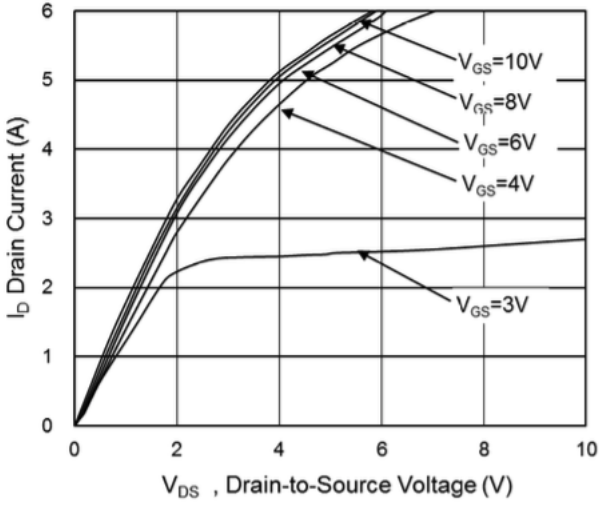

**Fig.1 Typical Output Characteristics**

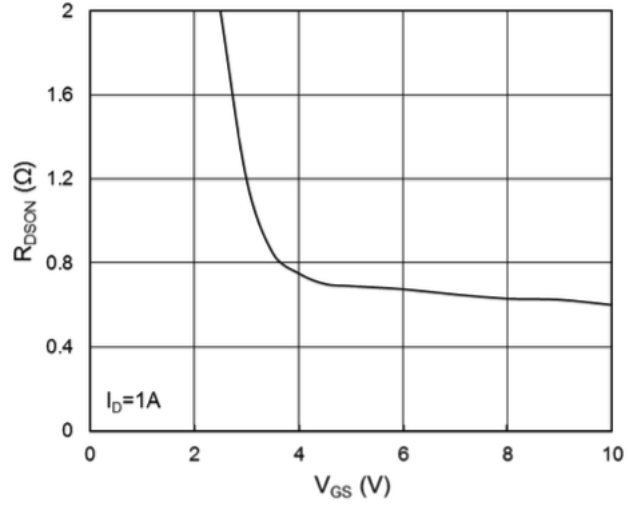

**Fig.2 On-Resistance vs G-S Voltage**

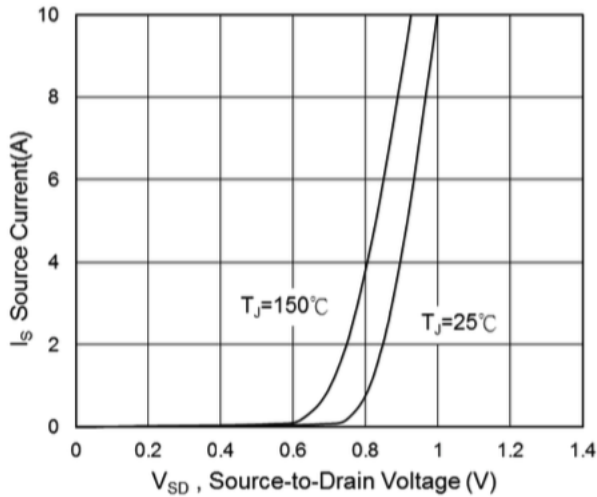

**Fig.3 Forward Characteristics of Reverse**

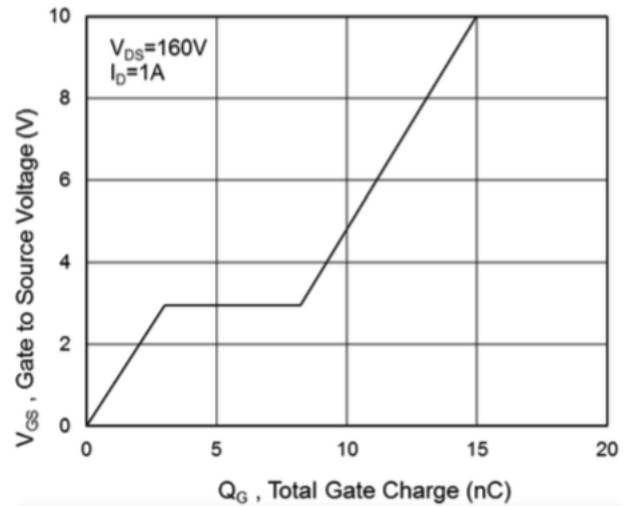

**Fig.4 Gate-Charge Characteristics**

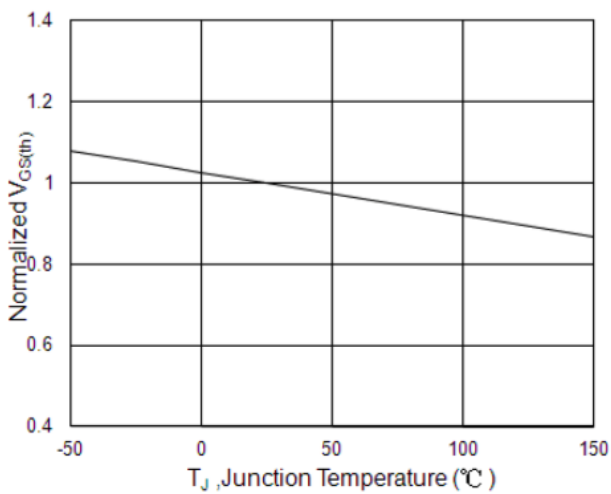

**Fig.5  $V_{GS(th)}$  vs  $T_J$**

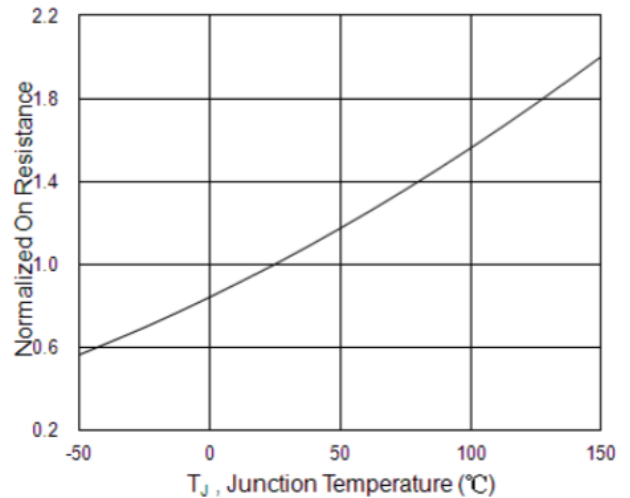

**Fig.6 Normalized  $R_{DS(on)}$  vs  $T_J$**



**N-Ch 200V Fast Switching MOSFETs**

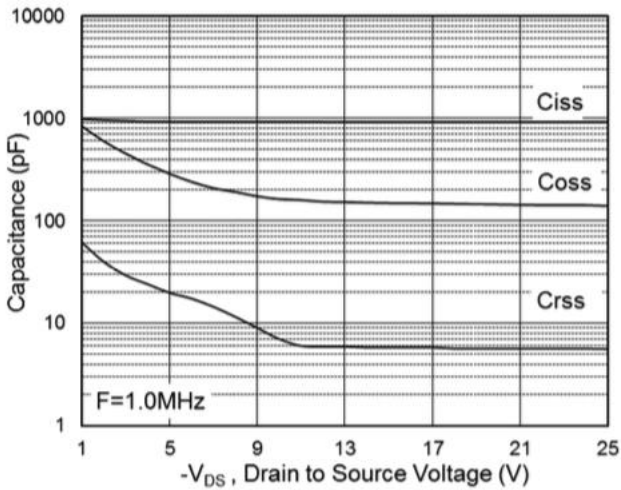

**Fig.7 Capacitance**

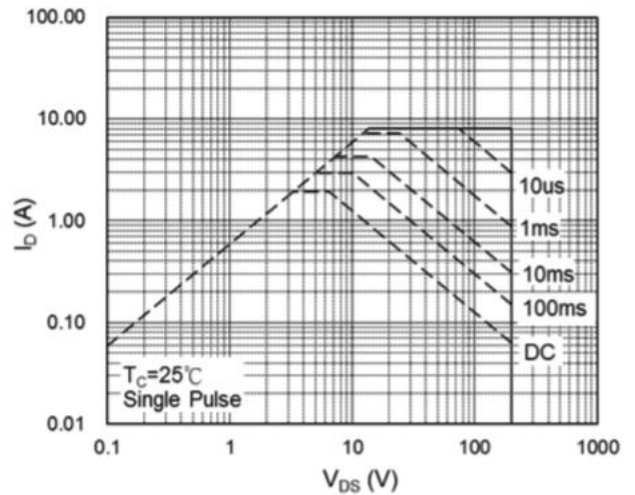

**Fig.8 Safe Operating Area**

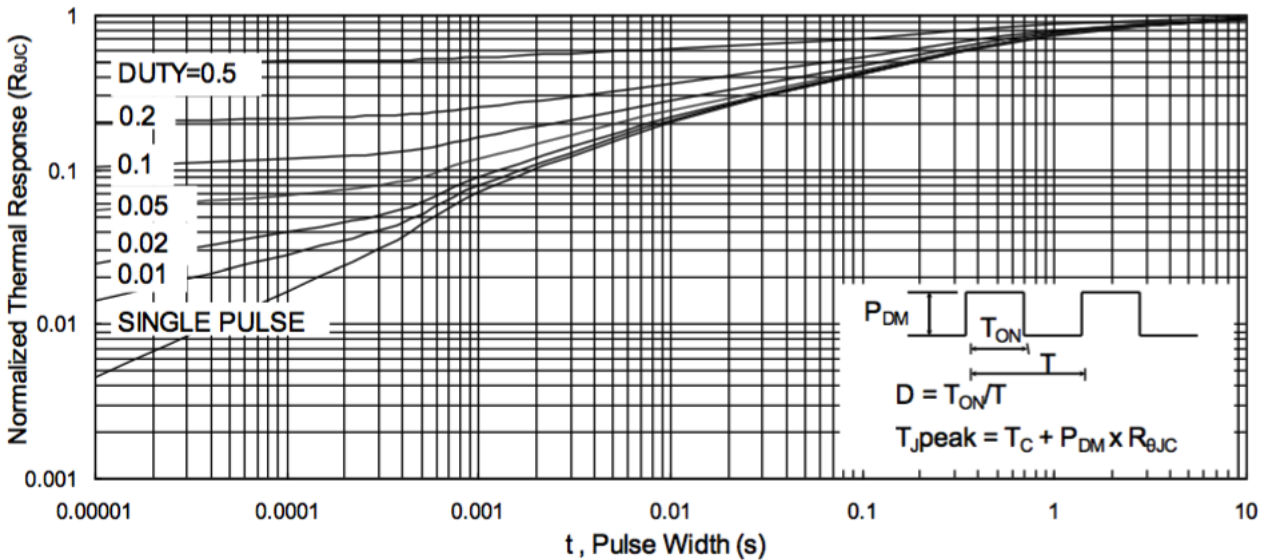

**Fig.9 Normalized Maximum Transient Thermal Impedance**

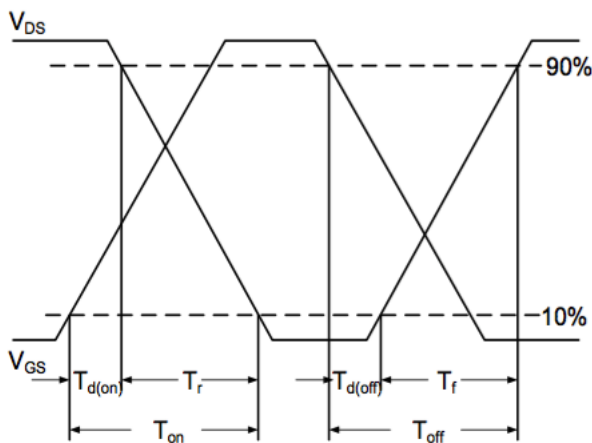

**Fig.10 Switching Time Waveform**

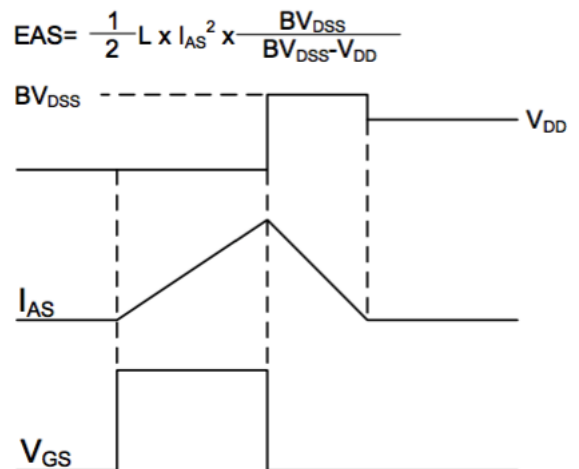

**Fig.11 Gate Charge Waveform**

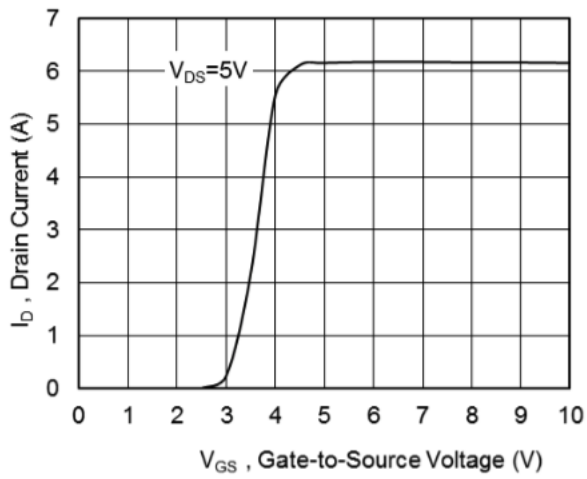

**Fig.12 Transfer Characteristics**

## Ordering Information

| Part Number | Package code | Packaging      |
|-------------|--------------|----------------|
| HSL03N20    | SOT-223      | 3000/Tape&Reel |

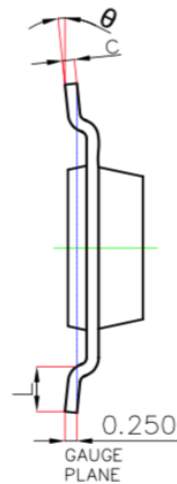
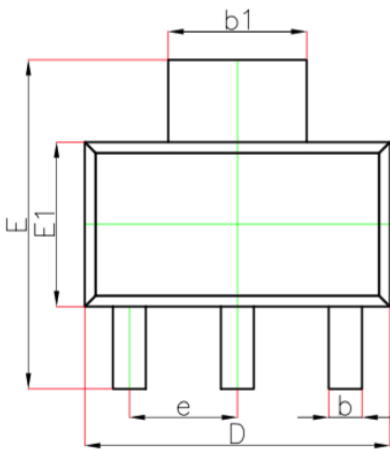

| Symbol | Dimensions In Millimeters |       | Dimensions In Inches |       |
|--------|---------------------------|-------|----------------------|-------|
|        | Min.                      | Max.  | Min.                 | Max.  |
| A      | —                         | 1.800 | —                    | 0.071 |
| A1     | 0.020                     | 0.100 | 0.001                | 0.004 |
| A2     | 1.500                     | 1.700 | 0.059                | 0.067 |
| b      | 0.660                     | 0.840 | 0.026                | 0.033 |
| b1     | 2.900                     | 3.100 | 0.114                | 0.122 |
| c      | 0.230                     | 0.350 | 0.009                | 0.014 |
| D      | 6.300                     | 6.700 | 0.248                | 0.264 |
| E      | 6.700                     | 7.300 | 0.264                | 0.287 |
| E1     | 3.300                     | 3.700 | 0.130                | 0.146 |
| e      | 2.300(BSC)                |       | 0.091(BSC)           |       |
| L      | 0.750                     | —     | 0.030                | —     |
| θ      | 0°                        | 10°   | 0°                   | 10°   |