

Dual P-Ch 40V Fast Switching MOSFETs
Description

The HSM4313 is the high cell density trenched P-ch MOSFETs, which provide excellent RDSON and gate charge for most of the synchronous buck converter applications.

The HSM4313 meet the RoHS and Green Product requirement, 100% EAS guaranteed with full function reliability approved.

- 100% EAS Guaranteed
- Green Device Available
- Super Low Gate Charge
- Excellent CdV/dt effect decline
- Advanced high cell density Trench technology

Product Summary

V _{DS}	-40	V
R _{DS(ON),max}	45	mΩ
I _D	-6.5	A

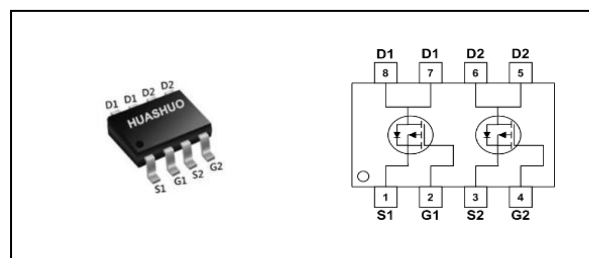
SOP8 Pin Configuration

Absolute Maximum Ratings

Symbol	Parameter	Rating	Units
V _{DS}	Drain-Source Voltage	-40	V
V _{GS}	Gate-Source Voltage	±20	V
I _D @T _C =25°C	Continuous Drain Current, -V _{GS} @ -10V ¹	-6.5	A
I _D @T _C =100°C	Continuous Drain Current, -V _{GS} @ -10V ¹	-4.7	A
I _{DM}	Pulsed Drain Current ²	-15	A
EAS	Single Pulse Avalanche Energy ³	36	mJ
I _{AS}	Avalanche Current	-27.2	A
P _D @T _C =25°C	Total Power Dissipation ⁴	3.1	W
T _{STG}	Storage Temperature Range	-55 to 150	°C
T _J	Operating Junction Temperature Range	-55 to 150	°C

Thermal Data

Symbol	Parameter	Typ.	Max.	Unit
R _{θJA}	Thermal Resistance Junction-Ambient ¹	---	85	°C/W
R _{θJC}	Thermal Resistance Junction-Case ¹	---	40	°C/W

Dual P-Ch 40V Fast Switching MOSFETs
P-Channel Electrical Characteristics ($T_J=25\text{ }^\circ\text{C}$, unless otherwise noted)

Symbol	Parameter	Conditions	Min.	Typ.	Max.	Unit
BV_{DSS}	Drain-Source Breakdown Voltage	$V_{GS}=0V, I_D=-250\mu A$	-40	---	---	V
$\Delta BV_{DSS}/\Delta T_J$	BV_{DSS} Temperature Coefficient	Reference to 25°C , $I_D=-1\text{mA}$	---	-0.012	---	$V/^\circ\text{C}$
$R_{DS(ON)}$	Static Drain-Source On-Resistance ²	$V_{GS}=-10V, I_D=-6A$	---	---	45	m Ω
		$V_{GS}=-4.5V, I_D=-3A$	---	---	75	
$V_{GS(th)}$	Gate Threshold Voltage	$V_{GS}=V_{DS}, I_D=-250\mu A$	-1.0	---	-2.5	V
$\Delta V_{GS(th)}$	$V_{GS(th)}$ Temperature Coefficient		---	4.32	---	$\text{mV}/^\circ\text{C}$
I_{DSS}	Drain-Source Leakage Current	$V_{DS}=-32V, V_{GS}=0V, T_J=25^\circ\text{C}$	---	---	1	μA
		$V_{DS}=-32V, V_{GS}=0V, T_J=55^\circ\text{C}$	---	---	5	
I_{GSS}	Gate-Source Leakage Current	$V_{GS}=\pm 20V, V_{DS}=0V$	---	---	± 100	nA
g_{fs}	Forward Transconductance	$V_{DS}=-5V, I_D=-6A$	---	12	---	S
R_g	Gate Resistance	$V_{DS}=0V, V_{GS}=0V, f=1\text{MHz}$	---	13	---	Ω
Q_g	Total Gate Charge (-4.5V)	$V_{DS}=-20V, V_{GS}=-4.5V, I_D=-6A$	---	9	---	nC
Q_{gs}	Gate-Source Charge		---	2.54	---	
Q_{gd}	Gate-Drain Charge		---	3.1	---	
$T_{d(on)}$	Turn-On Delay Time	$V_{DD}=-15V, V_{GS}=-10V, R_G=3.3\Omega, I_D=-1A$	---	19.2	---	ns
T_r	Rise Time		---	12.8	---	
$T_{d(off)}$	Turn-Off Delay Time		---	48.6	---	
T_f	Fall Time		---	4.6	---	
C_{iss}	Input Capacitance	$V_{DS}=-15V, V_{GS}=0V, f=1\text{MHz}$	---	1004	---	pF
C_{oss}	Output Capacitance		---	108	---	
C_{rss}	Reverse Transfer Capacitance		---	80	---	

Diode Characteristics

Symbol	Parameter	Conditions	Min.	Typ.	Max.	Unit
I_S	Continuous Source Current ^{1,5}	$V_G=V_D=0V$, Force Current	---	---	-4	A
V_{SD}	Diode Forward Voltage ²	$V_{GS}=0V, I_S=-1A, T_J=25^\circ\text{C}$	---	---	-1	V

Note :

- 1.The data tested by surface mounted on a 1 inch² FR-4 board with 2OZ copper.
- 2.The data tested by pulsed , pulse width $\leq 300\mu\text{s}$, duty cycle $\leq 2\%$
- 3.The EAS data shows Max. rating . The test condition is $V_{DD}=-25V, V_{GS}=-10V, L=0.1\text{mH}, I_{AS}=-27.2A$
- 4.The power dissipation is limited by 150°C junction temperature
- 5.The data is theoretically the same as I_D and I_{DM} , in real applications , should be limited by total power dissipation.

Dual P-Ch 40V Fast Switching MOSFETs

P-Channel Typical Characteristics

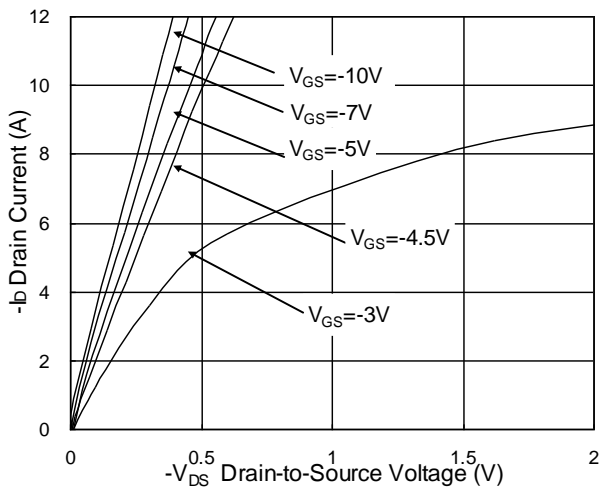

Fig.1 Typical Output Characteristics

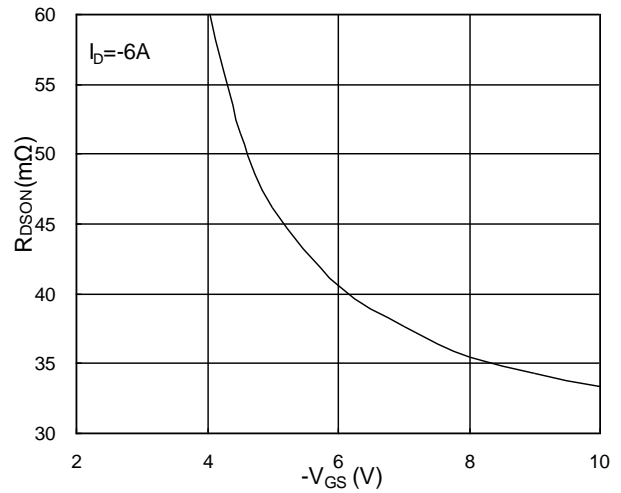

Fig.2 On-Resistance v.s Gate-Source

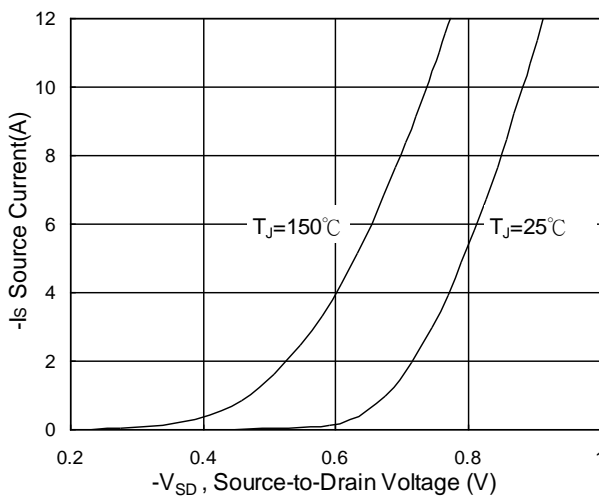

Fig.3 Forward Characteristics of Reverse

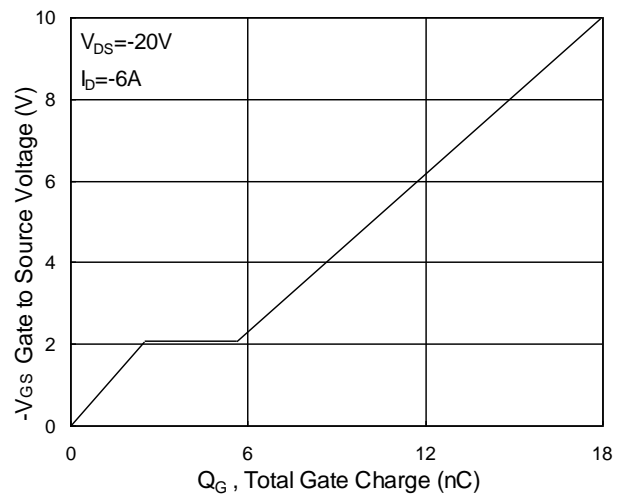

Fig.4 Gate-Charge Characteristics

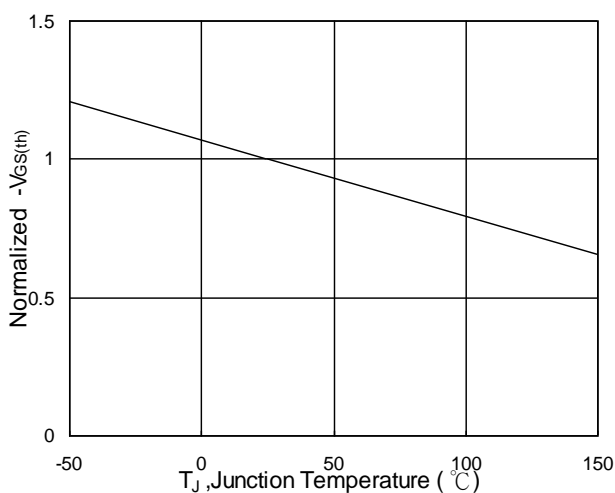

Fig.5 Normalized $V_{GS(th)}$ v.s T_J

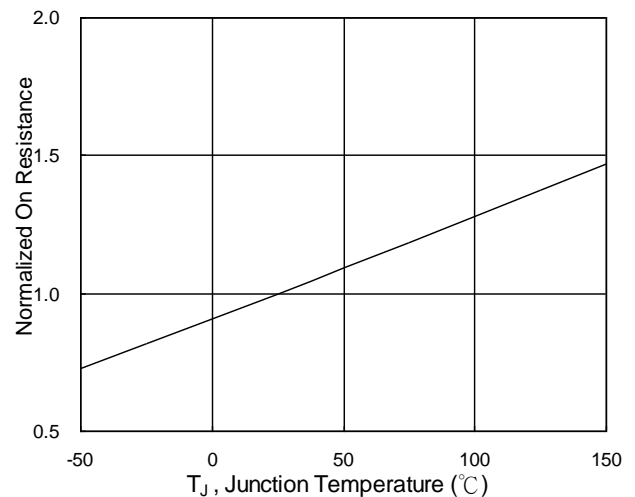

Fig.6 Normalized $R_{DS(on)}$ v.s T_J



Dual P-Ch 40V Fast Switching MOSFETs

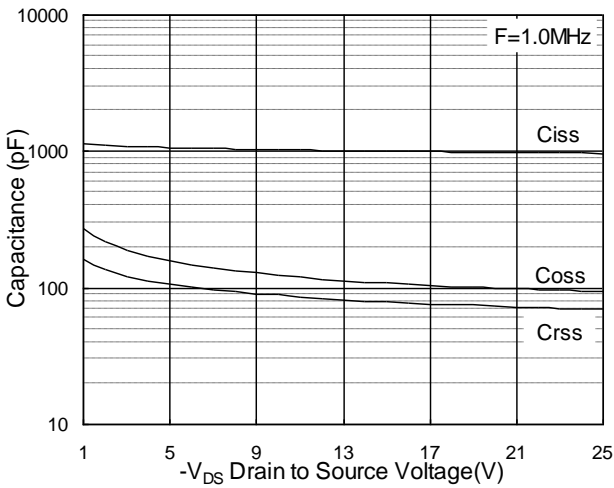

Fig.7 Capacitance

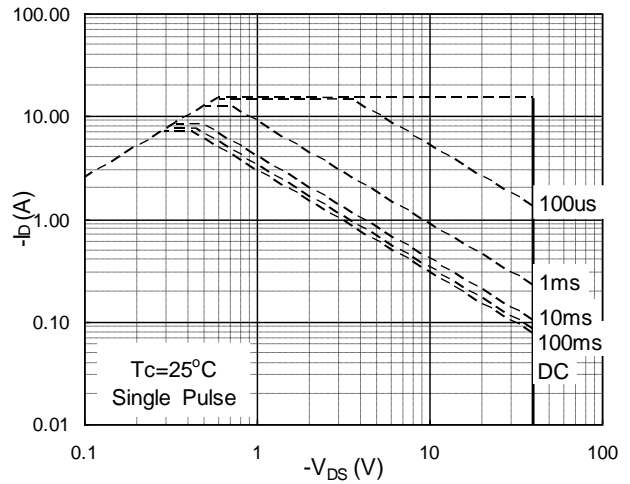

Fig.8 Safe Operating Area

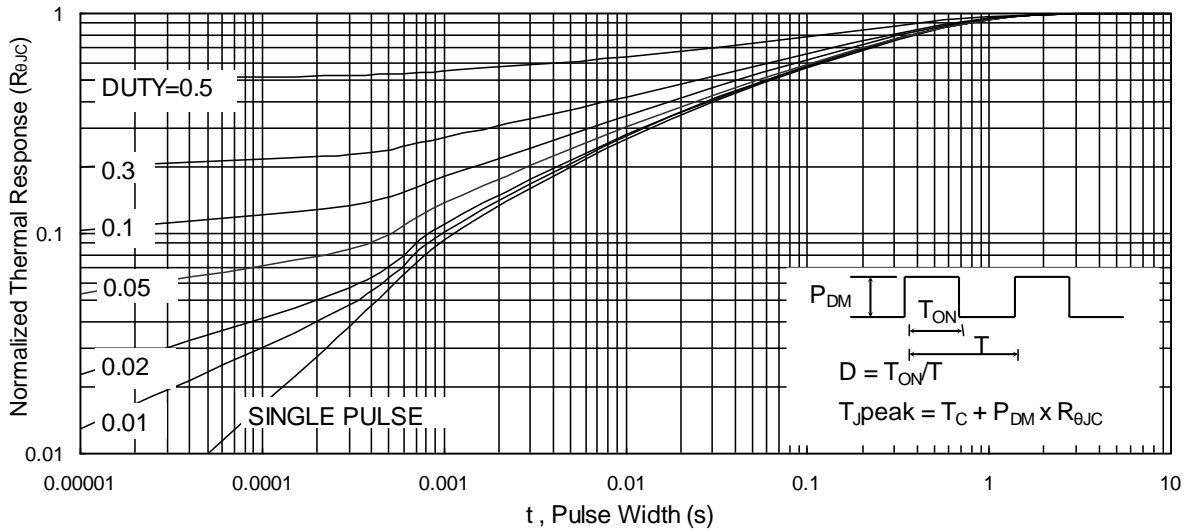

Fig.9 Normalized Maximum Transient Thermal Impedance

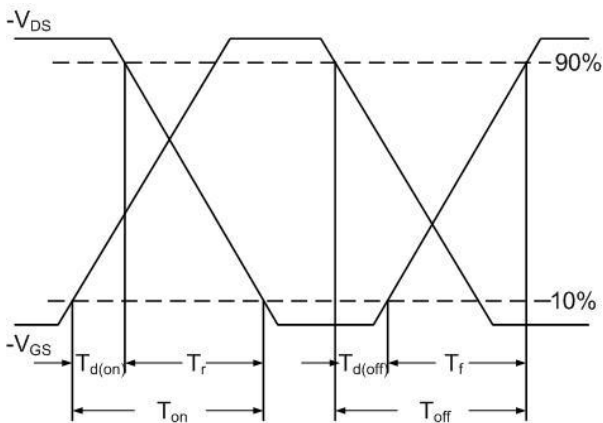

Fig.10 Switching Time Waveform

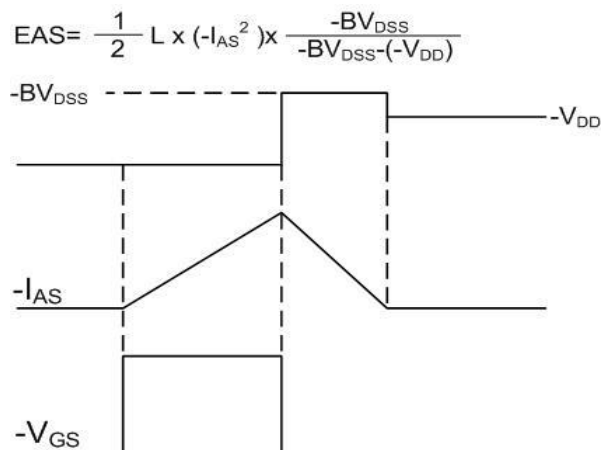

Fig.11 Unclamped Inductive Waveform

Ordering Information

Part Number	Package code	Packaging
HSM4313	SOP-8	2500/Tape&Reel

