

Description

The HSU60N02 is the high cell density trench N-ch MOSFETs, which provide excellent RDSON and gate charge for most of the synchronous buck converter applications.

The HSU60N02 meet the RoHS and Green Product requirement, 100% EAS guaranteed with full function reliability approved.

- 100% EAS Guaranteed
- Green Device Available
- Super Low Gate Charge
- Battery protection
- Power management

Product Summary

V _{DS}	20	V
R _{DS(ON),typ}	4	mΩ
I _D	60	A

TO252 Pin Configuration

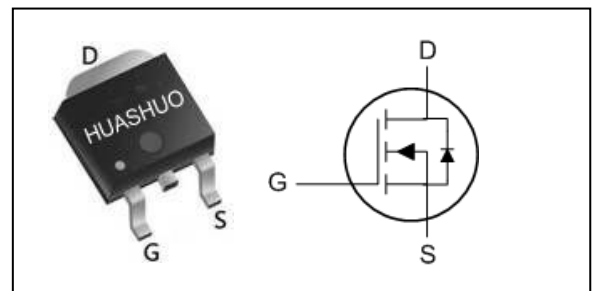

Absolute Maximum Ratings

Symbol	Parameter	Rating	Units
V _{DS}	Drain-Source Voltage	20	V
V _{GS}	Gate-Source Voltage	±12	V
I _D @T _C =25°C	Continuous Drain Current, V _{GS} @ 10V ₁	60	A
I _D @T _C =100°C	Continuous Drain Current, V _{GS} @ 10V ₁	43	A
I _{DM}	Pulsed Drain Current ₂	200	A
EAS	Single Pulse Avalanche Energy ₃	180	mJ
P _D @T _C =25°C	Total Power Dissipation ₄	60	W
T _{STG}	Storage Temperature Range	-55 to 175	°C
T _J	Operating Junction Temperature Range	-55 to 175	°C

Thermal Data

Symbol	Parameter	Typ.	Max.	Unit
R _{θJA}	Thermal Resistance Junction-ambient (Steady State) ₁	---	50	°C/W
R _{θJA}	Thermal Resistance Junction-Ambient ₁ (t ≤ 10s)	---	25	°C/W
R _{θJC}	Thermal Resistance Junction-Case ₁	---	2	°C/W



Electrical Characteristics (T_J=25 °C, unless otherwise noted)

Symbol	Parameter	Conditions	Min.	Typ.	Max.	Unit
BV _{DSS}	Drain-Source Breakdown Voltage	V _{GS} =0V, I _D =250uA	20	---	---	V
ΔBV _{DSS} /ΔT _J	BVDSS Temperature Coefficient	Reference to 25°C, I _D =1mA	---	0.028	---	V/°C
R _{DS(ON)}	Static Drain-Source On-Resistance ₂	V _{GS} =4.5V, I _D =30A	---	4	5.5	mΩ
		V _{GS} =2.5V, I _D =15A	---	6	9	
V _{GS(th)}	Gate Threshold Voltage	V _{GS} =V _{DS} , I _D =250uA	0.5	0.8	1	V
ΔV _{GS(th)}	V _{GS(th)} Temperature Coefficient		---	-6.16	---	mV/°C
I _{DSS}	Drain-Source Leakage Current	V _{DS} =20V, V _{GS} =0V, T _J =25°C	---	---	1	uA
		V _{DS} =20V, V _{GS} =0V, T _J =55°C	---	---	5	
I _{GSS}	Gate-Source Leakage Current	V _{GS} =±12V, V _{DS} =0V	---	---	±100	nA
g _{fs}	Forward Transconductance	V _{DS} =10V, I _D =20A	15	---	---	S
R _g	Gate Resistance	V _{DS} =0V, V _{GS} =0V, f=1MHz	---	1.7	---	Ω
Q _g	Total Gate Charge (4.5V)	V _{DS} =20V, V _{GS} =10V, I _D =40A	---	83	---	nC
Q _{gs}	Gate-Source Charge		---	15	---	
Q _{gd}	Gate-Drain Charge		---	32	---	
T _{d(on)}	Turn-On Delay Time	V _{DD} =15V, V _{GS} =10V, R _G =3.3Ω I _D =15A	---	10	---	ns
T _r	Rise Time		---	15	---	
T _{d(off)}	Turn-Off Delay Time		---	31	---	
T _f	Fall Time		---	15	---	
C _{iss}	Input Capacitance	V _{DS} =20V, V _{GS} =0V, f=1MHz	---	2200	---	pF
C _{oss}	Output Capacitance		---	400	---	
C _{rss}	Reverse Transfer Capacitance		---	270	---	

Diode Characteristics

Symbol	Parameter	Conditions	Min.	Typ.	Max.	Unit
I _S	Continuous Source Current _{1,5}	V _G =V _D =0V, Force Current	---	---	60	A
I _{SM}	Pulsed Source Current _{2,5}		---	---	220	A
V _{SD}	Diode Forward Voltage ₂	V _{GS} =0V, I _S =30A, T _J =25°C	---	---	1.4	V
t _{rr}	Reverse Recovery Time	I _F =30A, di/dt=100A/μs,	---	31	---	nS
Q _{rr}	Reverse Recovery Charge	T _J =25°C	---	60	---	nC

Note :

- 1.The data tested by surface mounted on a 1 inch² FR-4 board with 2OZ copper.
- 2.The data tested by pulsed , pulse width ≤ 300us , duty cycle ≤ 2%
- 3.The EAS data shows Max. rating . The test condition is V_{DD}=20V,V_{GS}=10V,L=0.1mH,I_{AS}=45A
- 4.The power dissipation is limited by 175°C junction temperature
- 5.The data is theoretically the same as I_D and I_{DM} , in real applications , should be limited by total power dissipation.



Typical Characteristics

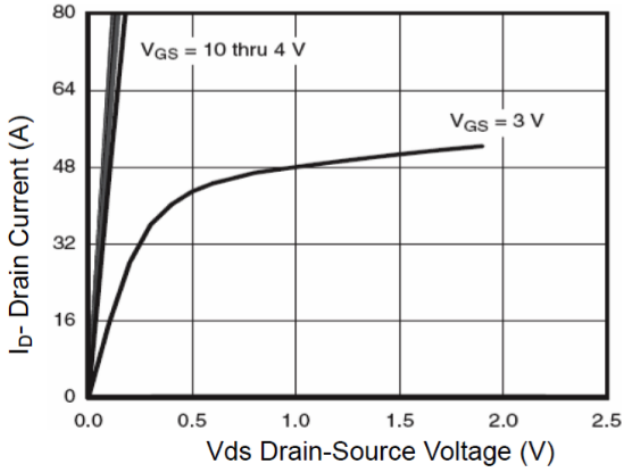

Figure 1 Output Characteristics

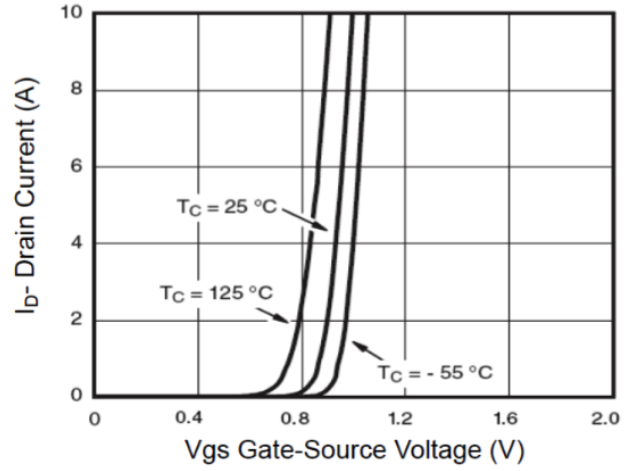

Figure 2 Transfer Characteristics

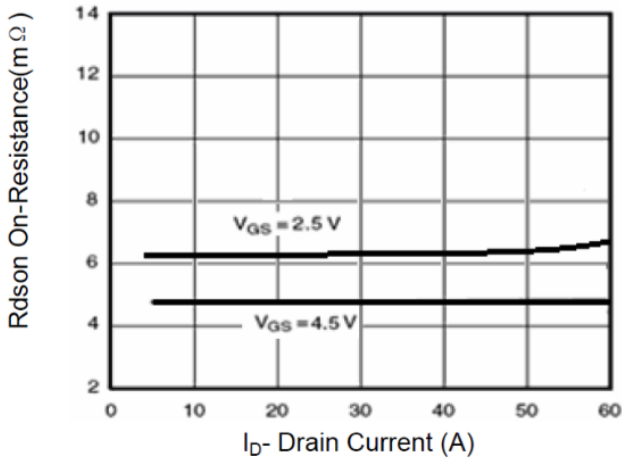

Figure 3 Rdson- Drain Current

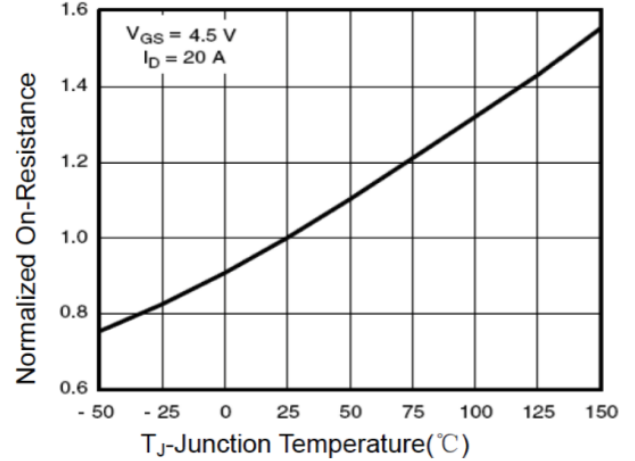

Figure 4 Rdson-Junction Temperature

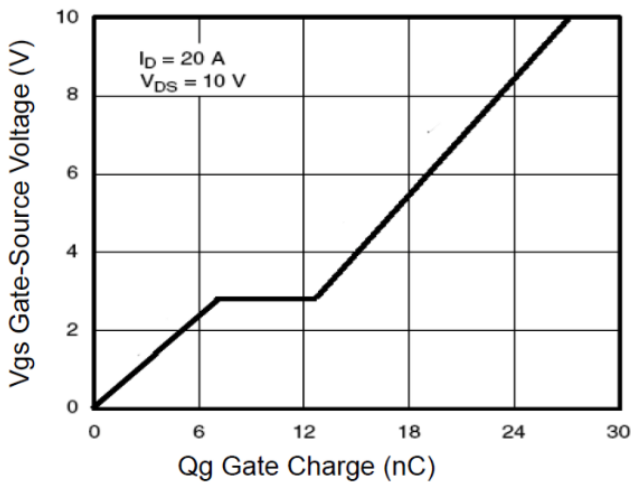

Figure 5 Gate Charge

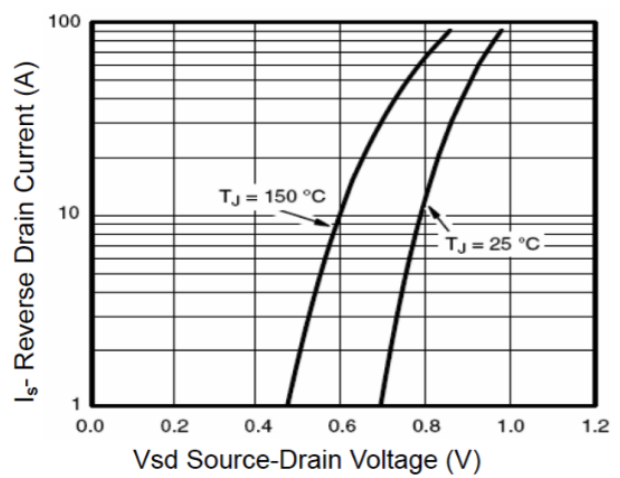

Figure 6 Source- Drain Diode Forward



N-Ch 20V Fast Switching MOSFETs

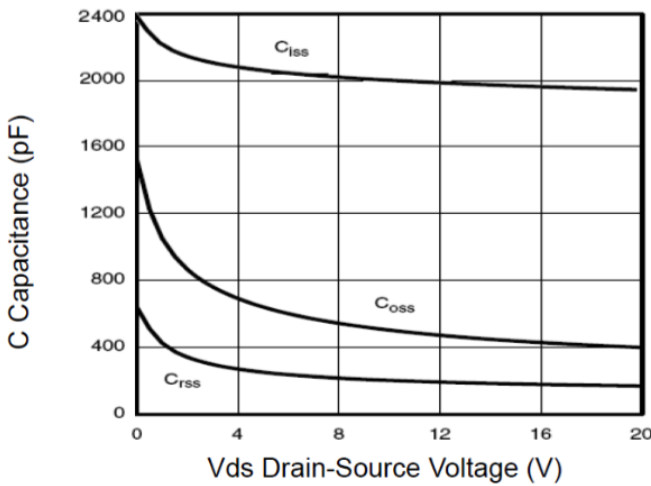

Figure 7 Capacitance vs Vds

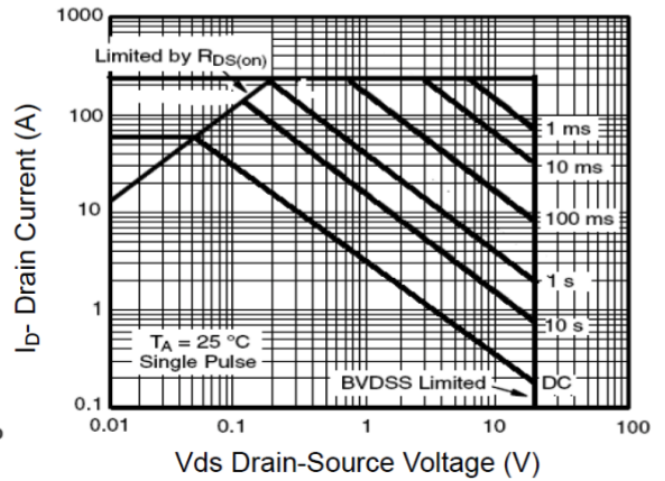

Figure 8 Safe Operation Area

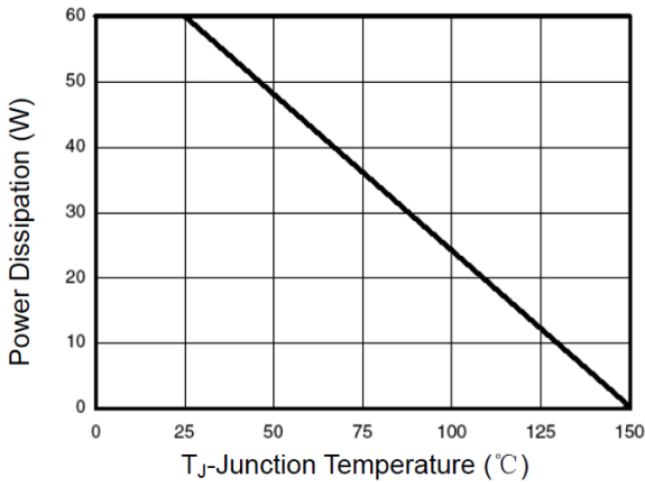

Figure 9 Power De-rating

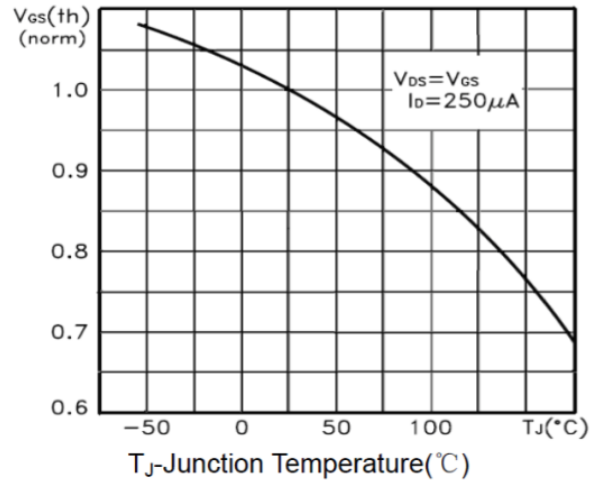

Figure 10 V_{GS(th)} vs Junction Temperature

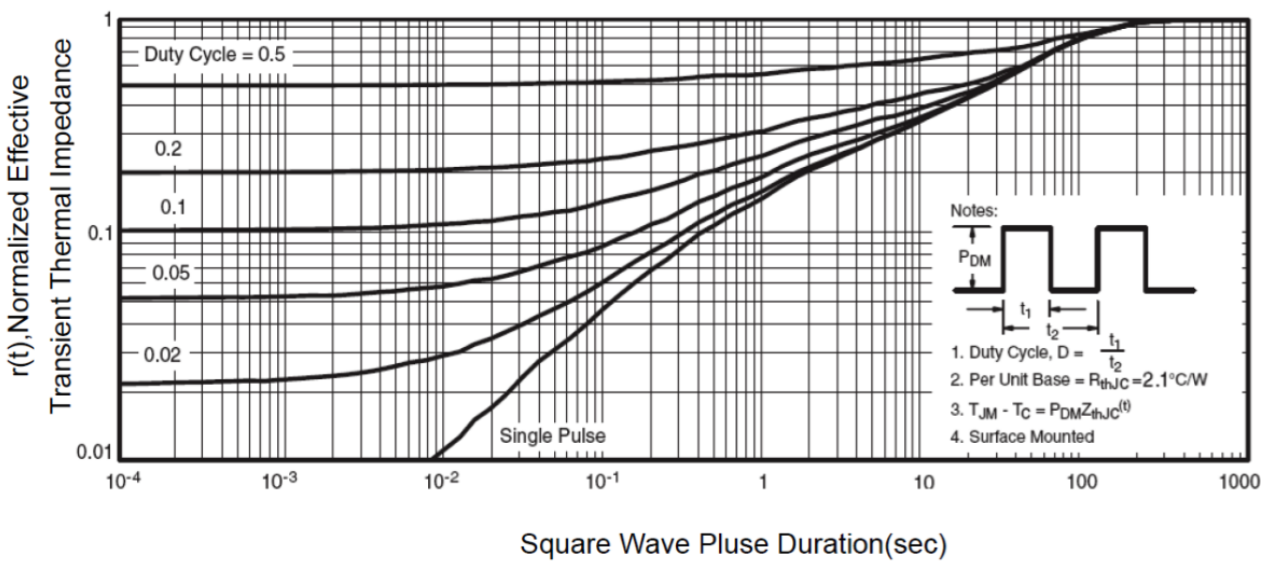
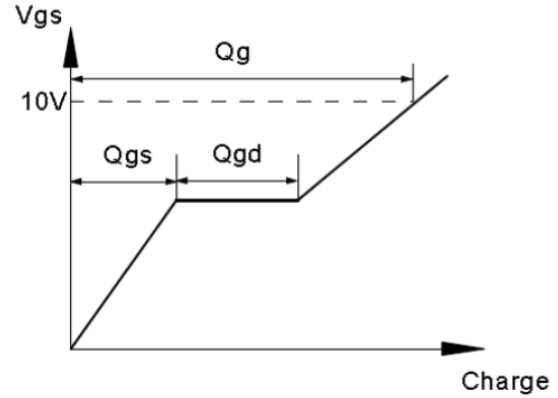
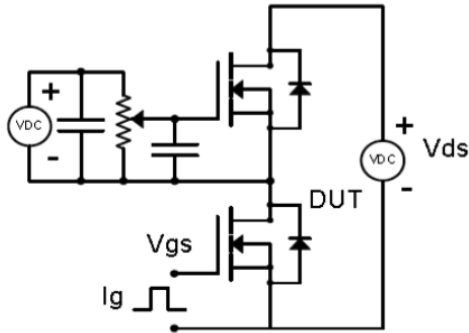

Figure 11 Normalized Maximum Transient Thermal Impedance



Test Circuit & Waveform

Gate Charge Test Circuit & Waveform



Resistive Switching Test Circuit & Waveforms

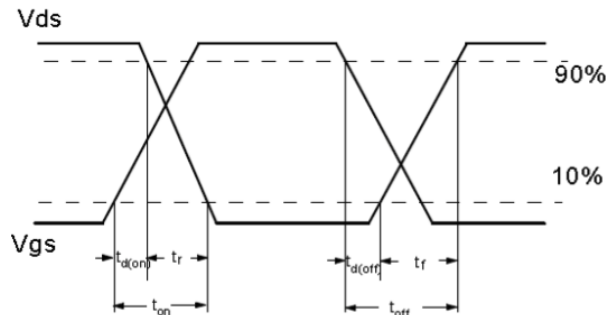
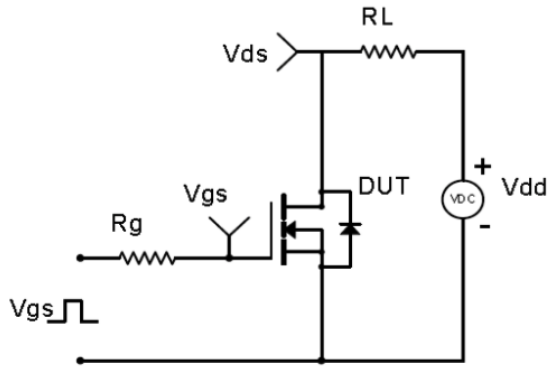

Unclamped Inductive Switching (UIS) Test Circuit & Waveforms

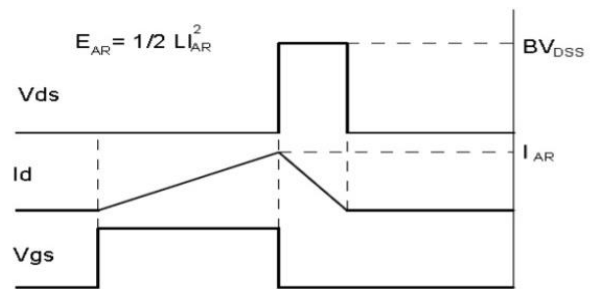
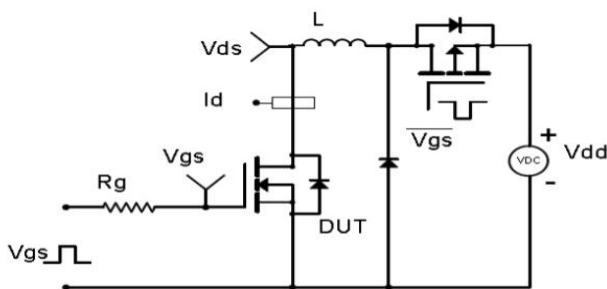

Diode Recovery Test Circuit & Waveforms

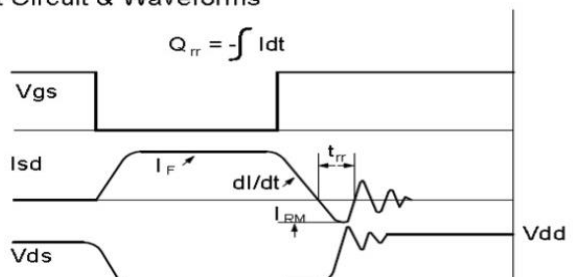
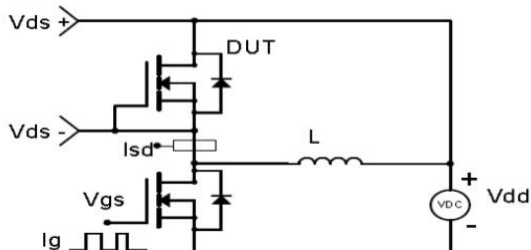



Ordering Information

Part Number	Package code	Packaging
HSU60N02	TO252-2	2500/Tape&Reel

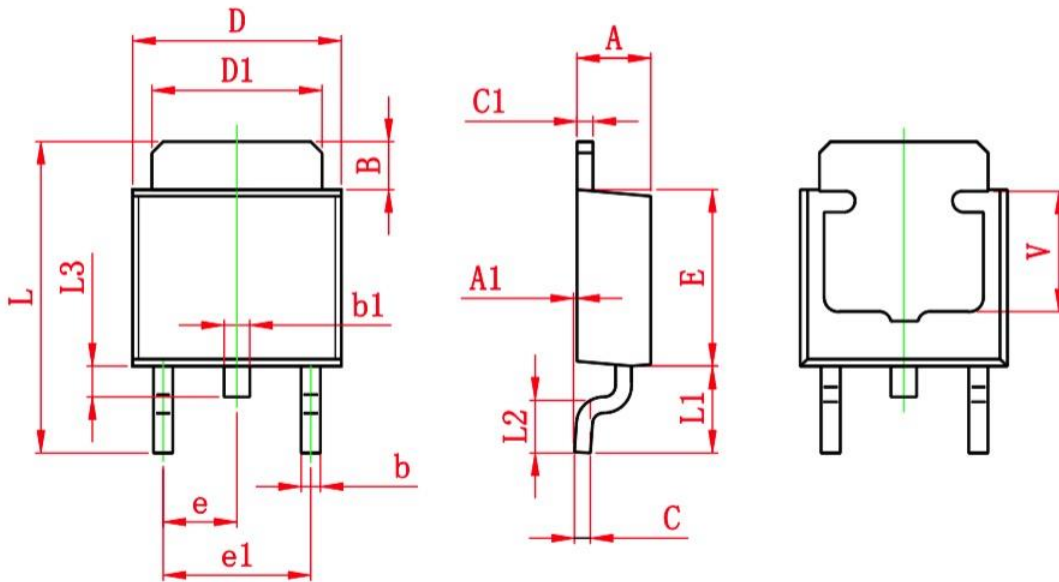

Symbol	Dimensions In Millimeters		Dimensions In Inches	
	Min.	Max.	Min.	Max.
A	2.200	2.400	0.087	0.094
A1	0.000	0.127	0.000	0.005
B	1.350	1.650	0.053	0.065
b	0.500	0.700	0.020	0.028
b1	0.700	0.900	0.028	0.035
c	0.430	0.580	0.017	0.023
c1	0.430	0.580	0.017	0.023
D	6.350	6.650	0.250	0.262
D1	5.200	5.400	0.205	0.213
E	5.400	5.700	0.213	0.224
e	2.300 TYP.		0.091 TYP.	
e1	4.500	4.700	0.177	0.185
L	9.500	9.900	0.374	0.390
L1	2.550	2.900	0.100	0.114
L2	1.400	1.780	0.055	0.070
L3	0.600	0.900	0.024	0.035
V	3.800 REF.		0.150 REF.	