

Description

The HSCB1216 is the high cell density trenched P-ch MOSFETs, which provide excellent $R_{DS(ON)}$ and gate charge for most of the synchronous buck converter applications.

The HSCB1216 meet the RoHS and Green Product requirement with full function reliability approved.

- Super Low Gate Charge
- Green Device Available
- Excellent CdV/dt effect decline
- Advanced high cell density Trench technology

Product Summary

V_{DS}	-12	V
$R_{DS(ON),typ}$	13	m Ω
I_D	-16	A

DFN2*2-6L Pin Configurations

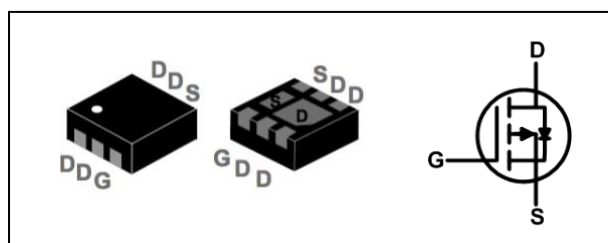

Absolute Maximum Ratings

Symbol	Parameter	Rating	Units
V_{DS}	Drain-Source Voltage	-12	V
V_{GS}	Gate-Source Voltage	± 12	V
$I_D@T_A=25^\circ C$	Continuous Drain Current, $V_{GS} @ -4.5V_1$	-16	A
$I_D@T_A=70^\circ C$	Continuous Drain Current, $V_{GS} @ -4.5V_1$	-12	A
I_{DM}	Pulsed Drain Current $_2$	-28	A
$P_D@T_A=25^\circ C$	Total Power Dissipation $_3$	3.5	W
$P_D@T_A=70^\circ C$	Total Power Dissipation $_3$	2.2	W
T_{STG}	Storage Temperature Range	-55 to 150	$^\circ C$
T_J	Operating Junction Temperature Range	-55 to 150	$^\circ C$

Thermal Data

Symbol	Parameter	Typ.	Max.	Unit
$R_{\theta JA}$	Thermal Resistance Junction-Ambient $_1$	---	36	$^\circ C/W$
$R_{\theta JC}$	Thermal Resistance Junction-Ambient $_1$	---	6.5	$^\circ C/W$

Electrical Characteristics (T_J=25 °C, unless otherwise noted)

Symbol	Parameter	Conditions	Min.	Typ.	Max.	Unit
B _V DSS	Drain-Source Breakdown Voltage	V _{GS} =0V, I _D =-250uA	-12	---	---	V
ΔB _V DSS/ΔT _J	B _V DSS Temperature Coefficient	Reference to 25°C, I _D =-1mA	---	-0.014	---	V/°C
R _{DS(ON)}	Static Drain-Source On-Resistance ₂	V _{GS} =-4.5V, I _D =-8A	---	13	15	mΩ
		V _{GS} =-2.5V, I _D =-6A	---	18	23	
V _{GS(th)}	Gate Threshold Voltage	V _{GS} =V _{DS} , I _D =-250uA	-0.5	-0.75	-1.2	V
ΔV _{GS(th)}	V _{GS(th)} Temperature Coefficient		---	3.95	---	mV/°C
I _{DSS}	Drain-Source Leakage Current	V _{DS} =-12V, V _{GS} =0V, T _J =25°C	---	---	-1	uA
		V _{DS} =-12V, V _{GS} =0V, T _J =55°C	---	---	-5	
I _{GSS}	Gate-Source Leakage Current	V _{GS} =±12V, V _{DS} =0V	---	---	±100	nA
g _{fs}	Forward Transconductance	V _{DS} =-10V, I _D =-8A	---	32	---	S
Q _g	Total Gate Charge (-4.5V)	V _{DS} =-6V, V _{GS} =-4.5V, I _D =-9A	---	13	---	nC
Q _{gs}	Gate-Source Charge		---	3	---	
Q _{gd}	Gate-Drain Charge		---	4.3	---	
T _{d(on)}	Turn-On Delay Time	V _{DD} =-10V, V _{GS} =-4.5V, R _G =3.3Ω, I _D =-3A	---	11	---	ns
T _r	Rise Time		---	31	---	
T _{d(off)}	Turn-Off Delay Time		---	30	---	
T _f	Fall Time		---	10	---	
C _{iss}	Input Capacitance	V _{DS} =-6V, V _{GS} =0V, f=1MHz	---	1300	---	pF
C _{oss}	Output Capacitance		---	390	---	
C _{rss}	Reverse Transfer Capacitance		---	304	---	

Diode Characteristics

Symbol	Parameter	Conditions	Min.	Typ.	Max.	Unit
I _S	Continuous Source Current _{1,4}	V _G =V _D =0V, Force Current	---	---	-16	A
I _{SM}	Pulsed Source Current _{2,4}		---	---	-28	A
V _{SD}	Diode Forward Voltage ₂	V _{GS} =0V, I _S =-1A, T _J =25°C	---	---	-1.2	V

Note :

- 1.The data tested by surface mounted on a 1 inch² FR-4 board with 20Z copper.
- 2.The data tested by pulsed, pulse width ≤ 300us, duty cycle ≤ 2%
- 3.The power dissipation is limited by 150°C junction temperature
- 4.The data is theoretically the same as I_D and I_{DM}, in real applications, should be limited by total power dissipation.

P-Ch 12V Fast Switching MOSFETs

Typical Characteristics

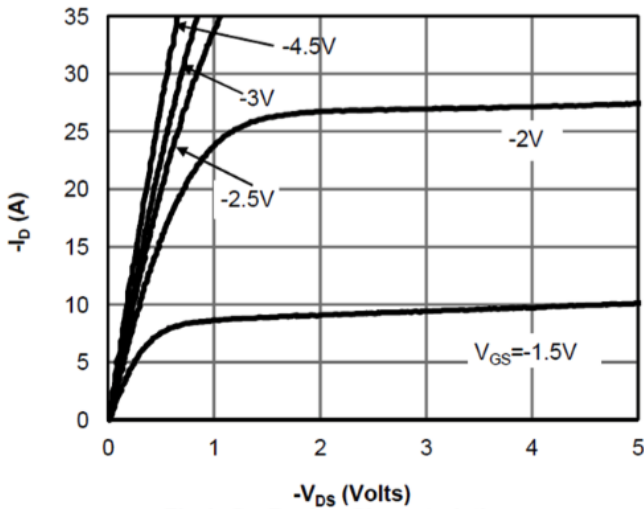

Fig 1: On-Region Characteristics

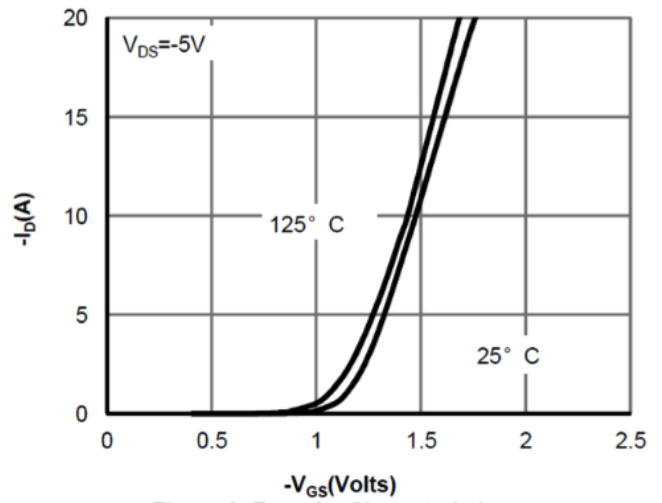

Figure 2: Transfer Characteristics

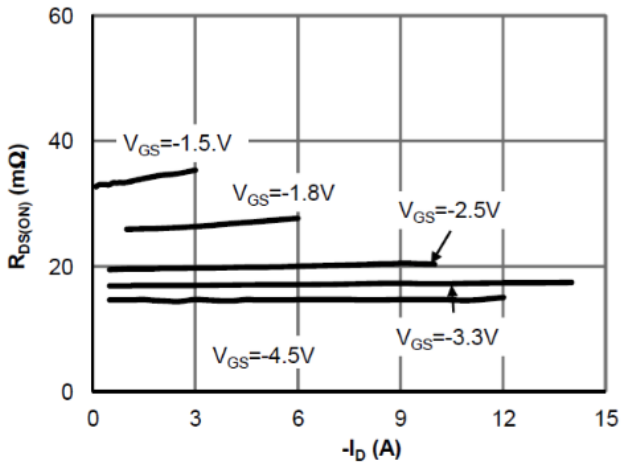

Figure 3: On-Resistance vs. Drain Current and Gate Voltage

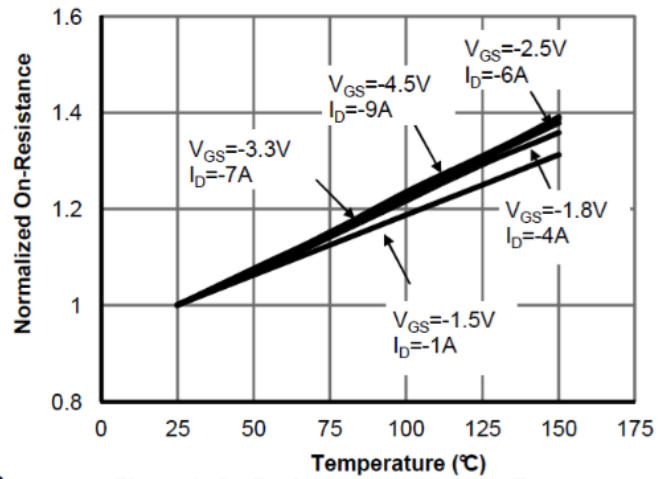

Figure 4: On-Resistance vs. Junction Temperature

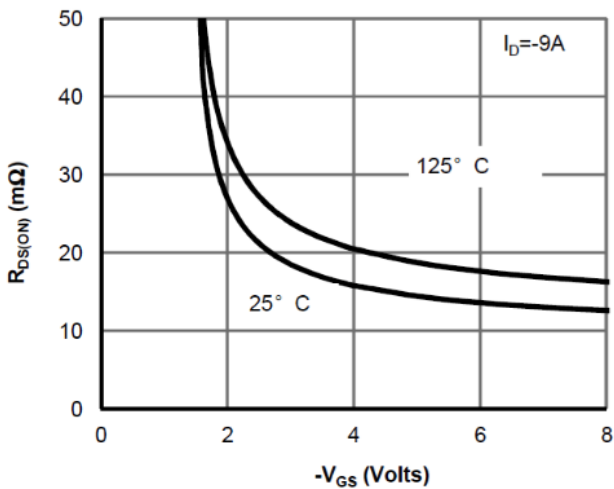

Figure 5: On-Resistance vs. Gate-Source Voltage

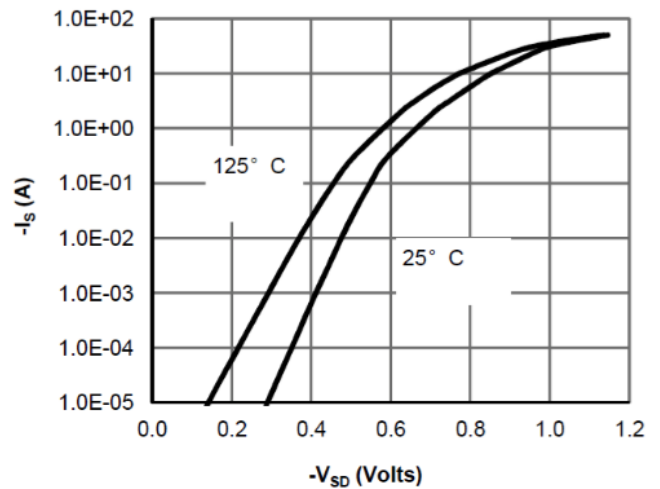

Figure 6: Body-Diode Characteristics

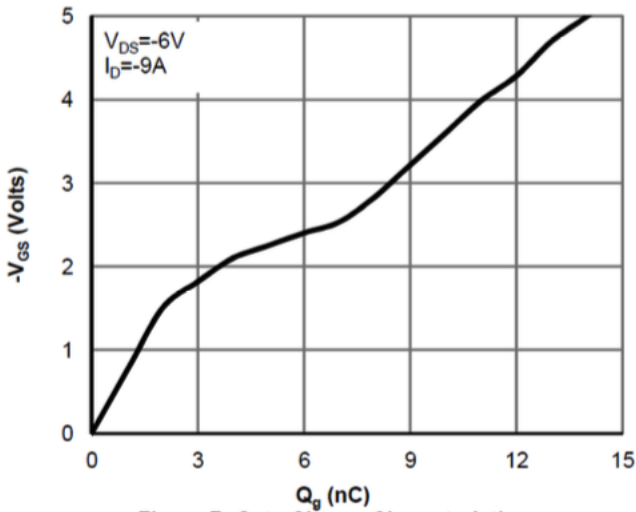

Figure 7: Gate-Charge Characteristics

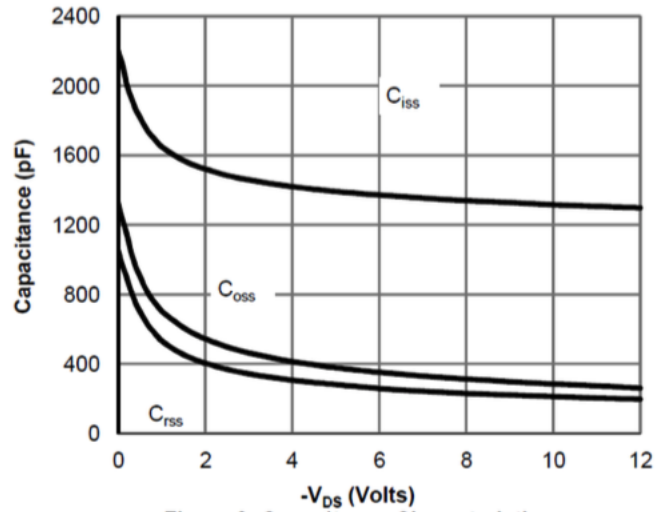

Figure 8: Capacitance Characteristics

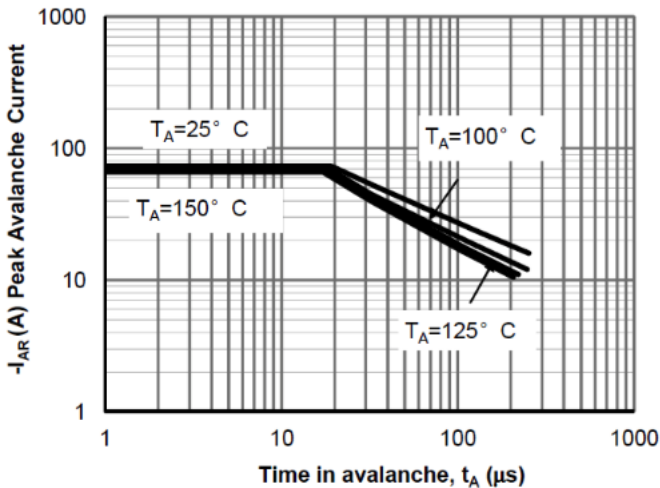

Figure 9: Single Pulse Avalanche capability

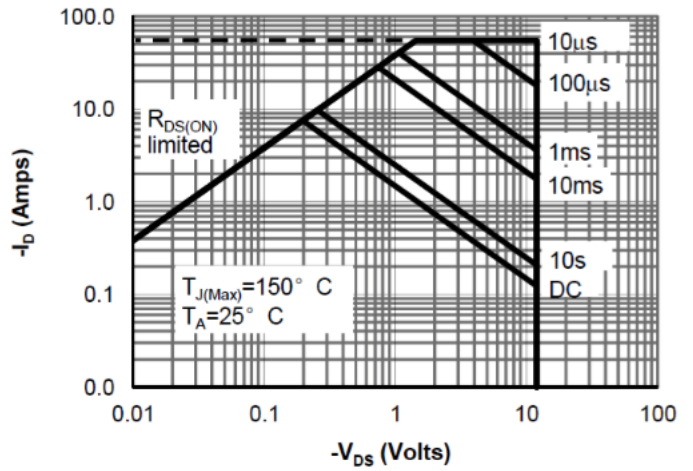

Figure 10: Maximum Forward Biased Safe Operating Area

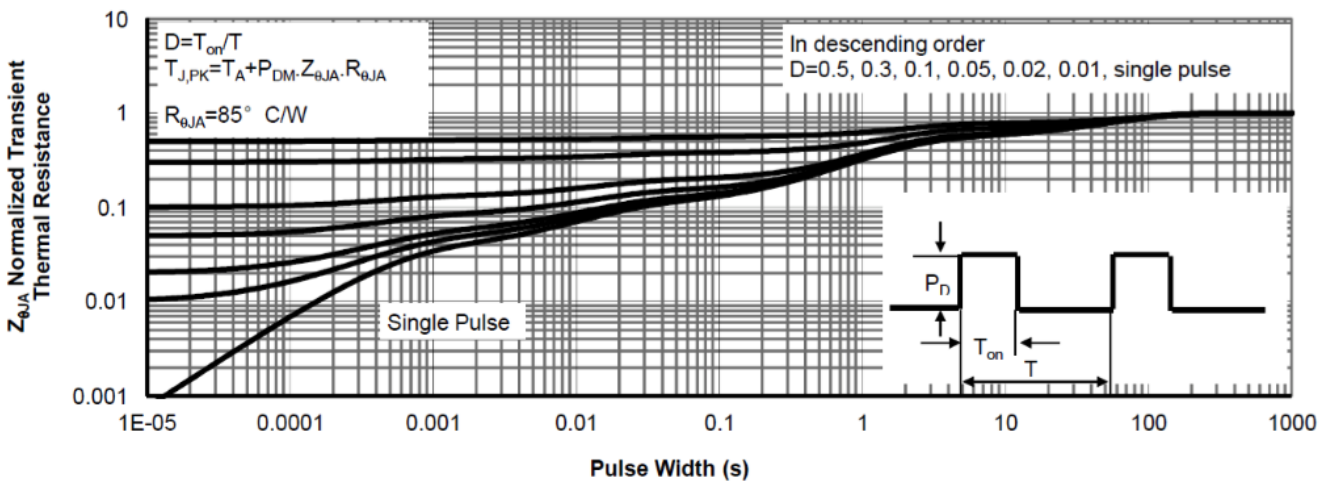
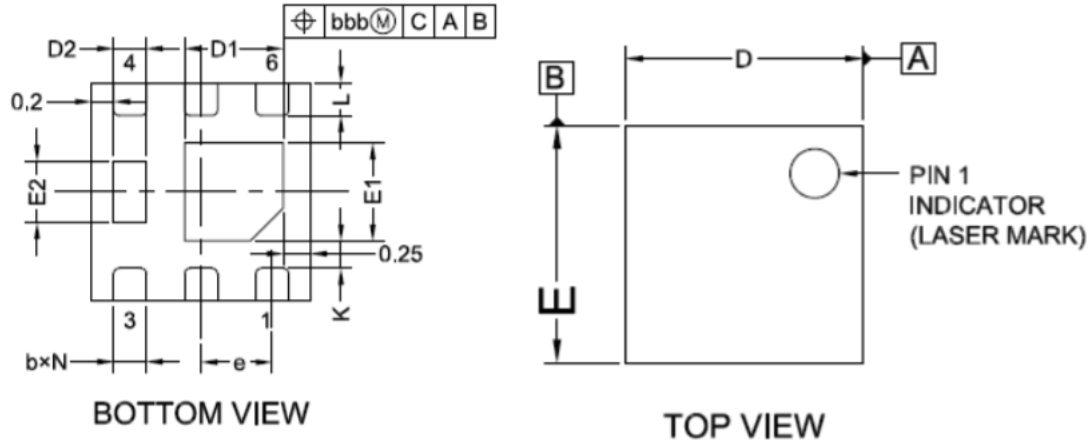

Figure 12: Normalized Maximum Transient Thermal Impedance



DFN2x2-6L 2EP PACKAGE INFORMATION



BOTTOM VIEW

TOP VIEW

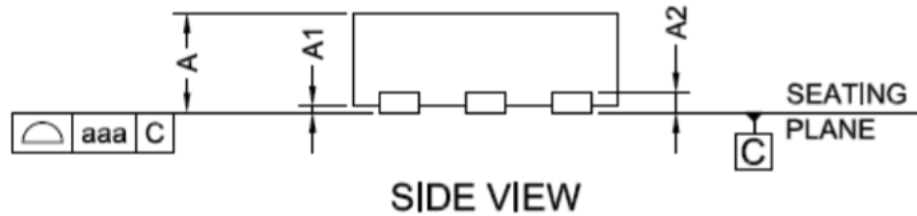

SIDE VIEW

COMMON DIMENSIONS
(UNITS OF MEASURE=MILLIMETER)

SYMBOL	MIN	TYP	MAX
A	0.50	0.55	0.60
A1	0.00	0.02	0.05
A2	0.152REF.		
b	0.25	0.30	0.35
D	1.95	2.00	2.05
D1	0.80	0.90	1.00
D2	0.25	0.30	0.35
E	1.95	2.00	2.05
E1	0.80	0.90	1.00
E2	0.46	0.56	0.66
e	0.65BSC		
L	0.25	0.30	0.35
J	0.40BSC		
K	0.20MIN		
N	6		
aaa	0.08		
bbb	0.10		