

Description

The HSCB2016 is the high cell density trenched N-ch MOSFETs, which provides excellent RDSON and efficiency for most of the small power switching and load switch applications.

The HSCB2016 meet the RoHS and Green Product requirement with full function reliability approved.

- Green Device Available
- Super Low Gate Charge
- Excellent Cdv/dt effect decline
- Advanced high cell density Trench technology

Product Summary

V _{DS}	20	V
R _{DS(ON),typ}	9	mΩ
I _D	16	A

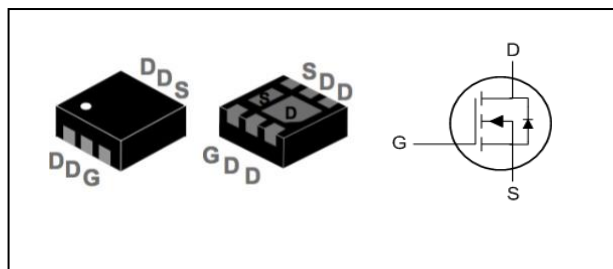
DFN2*2-6L Pin Configuration

Absolute Maximum Ratings

Symbol	Parameter	Rating	Units
V _{DS}	Drain-Source Voltage	20	V
V _{GS}	Gate-Source Voltage	±12	V
I _D @T _A =25°C	Continuous Drain Current, V _{GS} @ 4.5V ¹	16	A
I _{DM}	Pulsed Drain Current ²	64	A
P _D @T _C =25°C	Total Power Dissipation ³	18	W
T _{STG}	Storage Temperature Range	-55 to 150	°C
T _J	Operating Junction Temperature Range	-55 to 150	°C

Thermal Data

Symbol	Parameter	Max.	Unit
R _{θJA}	Thermal Resistance Junction-ambient ¹	100	°C/W

Electrical Characteristics (T_J=25 °C, unless otherwise noted)

Symbol	Parameter	Conditions	Min.	Typ.	Max.	Unit
BV _{DSS}	Drain-Source Breakdown Voltage	V _{GS} =0V, I _D =250uA	20	---	---	V
ΔBV _{DSS} /ΔT _J	BVDSS Temperature Coefficient	Reference to 25°C, I _D =1mA	---	0.018	---	V/°C
R _{DS(ON)}	Static Drain-Source On-Resistance ²	V _{GS} =4.5V, I _D =16A	---	9	12	mΩ
		V _{GS} =2.5V, I _D =12A	---	11.5	14	
V _{GS(th)}	Gate Threshold Voltage	V _{GS} =V _{DS} , I _D =250uA	0.5	0.7	0.9	V
ΔV _{GS(th)}	V _{GS(th)} Temperature Coefficient		---	-3.1	---	mV/°C
I _{DSS}	Drain-Source Leakage Current	V _{DS} =16V, V _{GS} =0V, T _J =25°C	---	---	1	uA
		V _{DS} =16V, V _{GS} =0V, T _J =55°C	---	---	5	
I _{GSS}	Gate-Source Leakage Current	V _{GS} =±12V, V _{DS} =0V	---	---	±100	nA
g _{fs}	Forward Transconductance	V _{DS} =5V, I _D =16A	---	10	---	S
Q _g	Total Gate Charge (4.5V)	V _{DS} =10V, V _{GS} =4.5V, I _D =16A	---	12	---	nC
Q _{gs}	Gate-Source Charge		---	2.3	---	
Q _{gd}	Gate-Drain Charge		---	1	---	
T _{d(on)}	Turn-On Delay Time	V _{DS} =10V, V _{GS} =4.5V, R _G =6Ω I _D =16A	---	10	---	ns
T _r	Rise Time		---	11	---	
T _{d(off)}	Turn-Off Delay Time		---	35	---	
T _f	Fall Time		---	31	---	
C _{iss}	Input Capacitance	V _{DS} =10V, V _{GS} =0V, f=1MHz	---	910	---	pF
C _{oss}	Output Capacitance		---	230	---	
C _{rss}	Reverse Transfer Capacitance		---	100	---	

Diode Characteristics

Symbol	Parameter	Conditions	Min.	Typ.	Max.	Unit
I _S	Continuous Source Current ^{1,4}	V _G =V _D =0V, Force Current	---	---	16	A
I _{SM}	Pulsed Source Current ^{2,4}		---	---	64	A
V _{SD}	Diode Forward Voltage ²	V _{GS} =0V, I _S =1A, T _J =25°C	---	---	1.2	V

Note :

1.The data tested by surface mounted on a 1 inch² FR-4 board with 2OZ copper.

2.The data tested by pulsed, pulse width ≤ 300us, duty cycle ≤ 2%

3.The power dissipation is limited by 150°C junction temperature

4.The data is theoretically the same as I_D and I_{DM}, in real applications, should be limited by total power dissipation.

Typical Characteristics

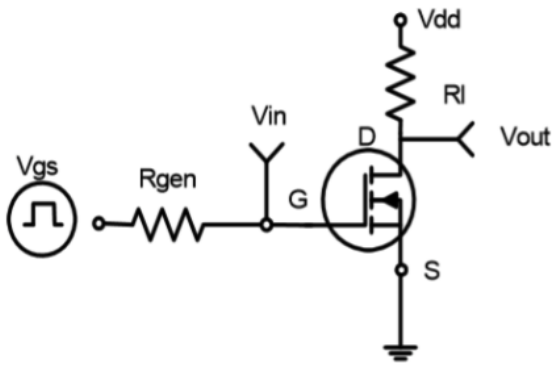

Figure 1: Switching Test Circuit

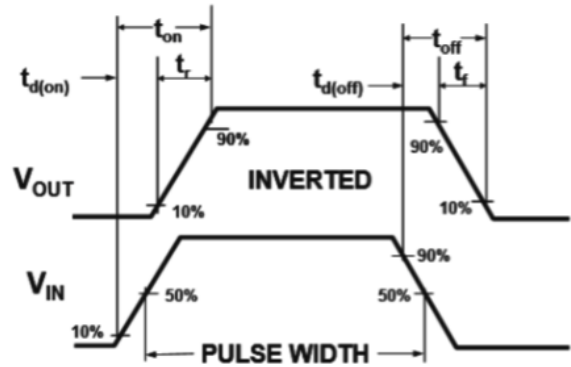

Figure 2: Switching Waveforms

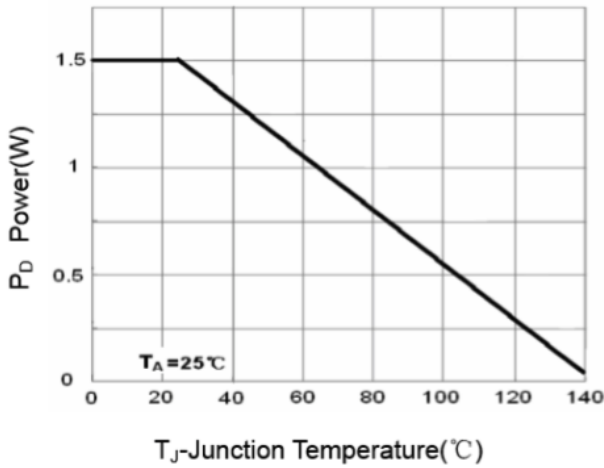

Figure 3 Power Dissipation

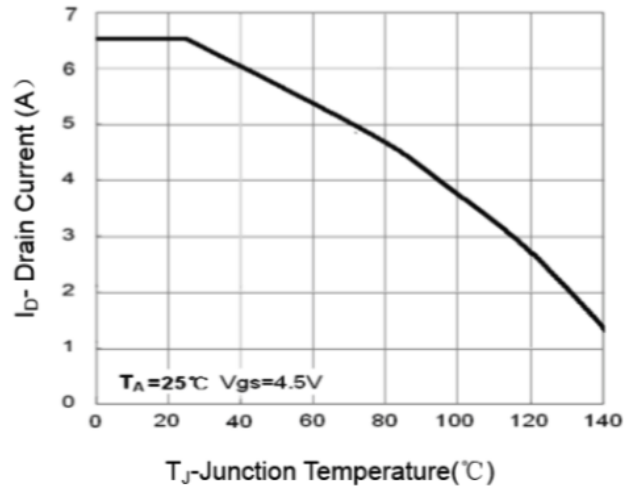

Figure 4 Drain Current

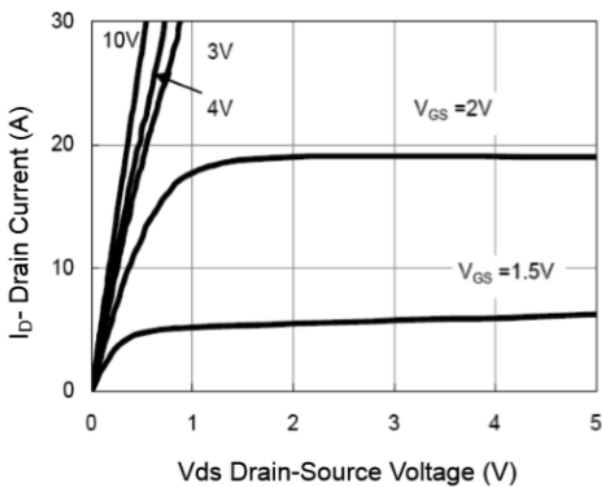

Figure 5 Output Characteristics

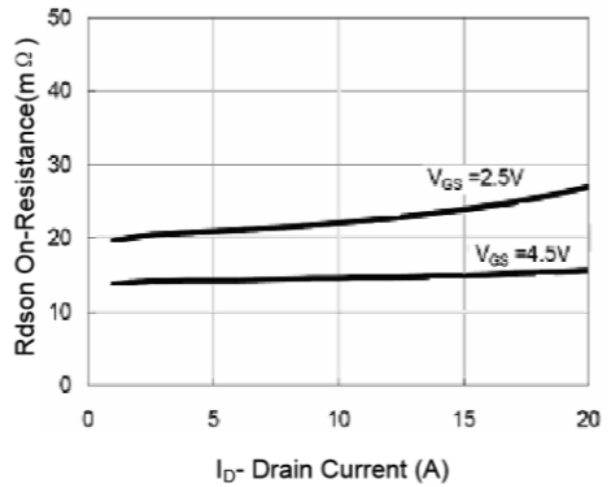

Figure 6 Drain-Source On-Resistance

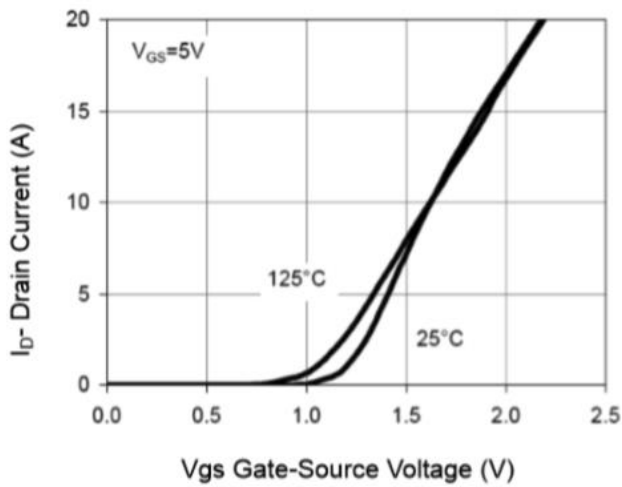

Figure 7 Transfer Characteristics

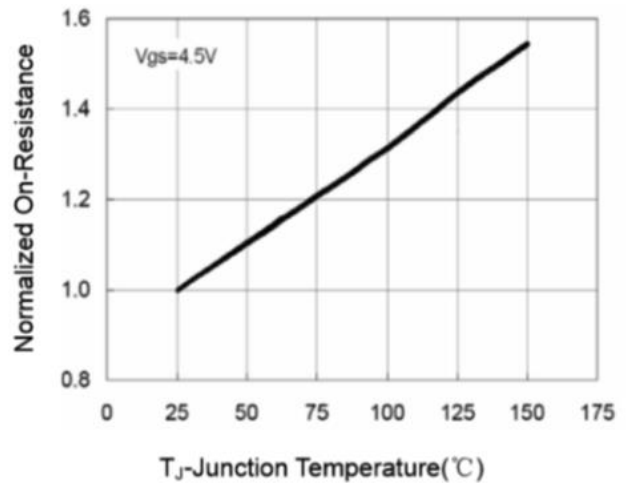

Figure 8 Drain-Source On-Resistance

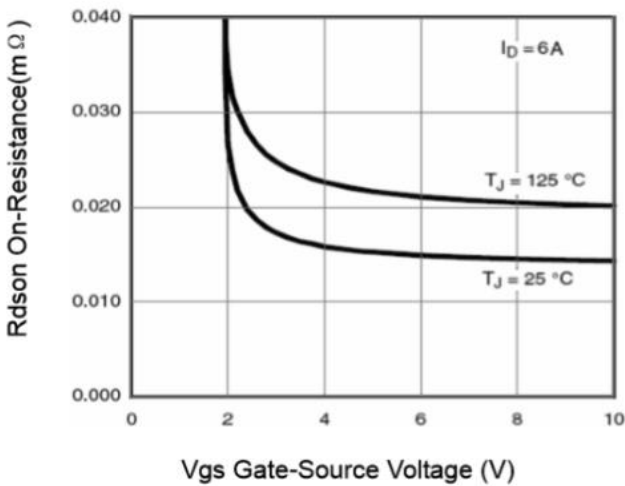

Figure 9 Rdson vs Vgs

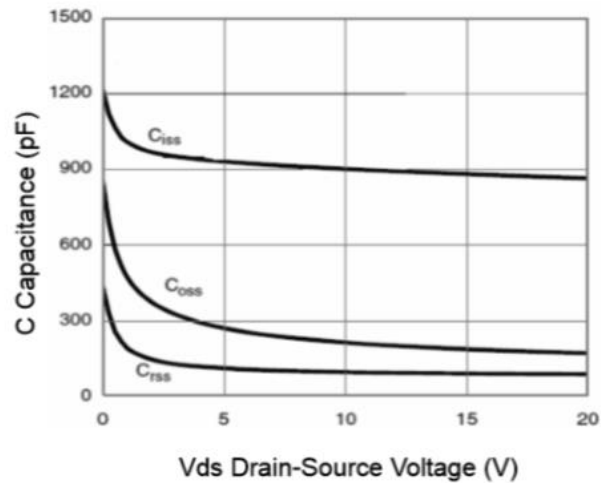

Figure 10 Capacitance vs Vds

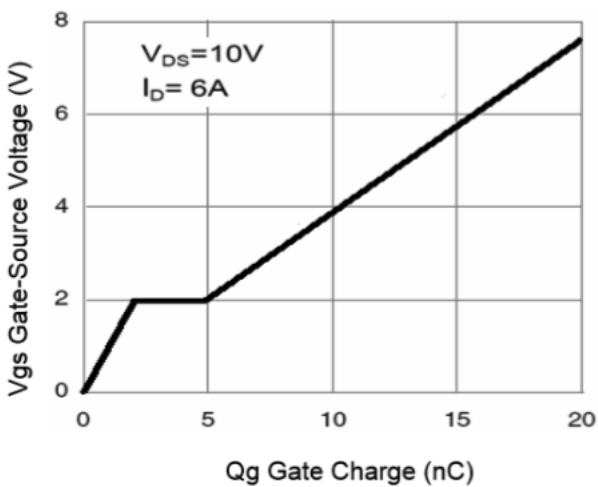

Figure 11 Gate Charge

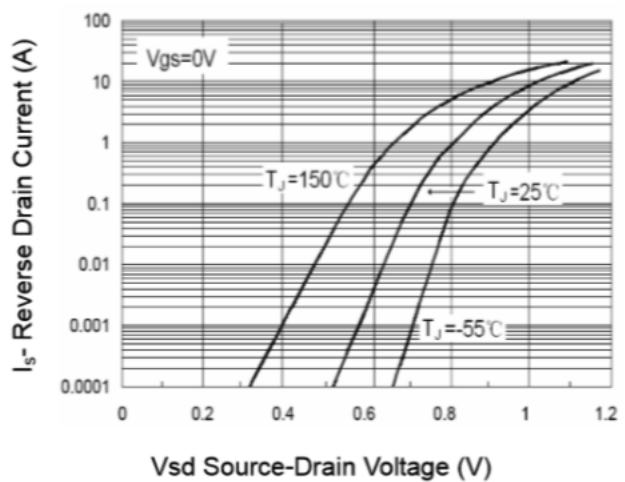

Figure 12 Source-Drain Diode Forward

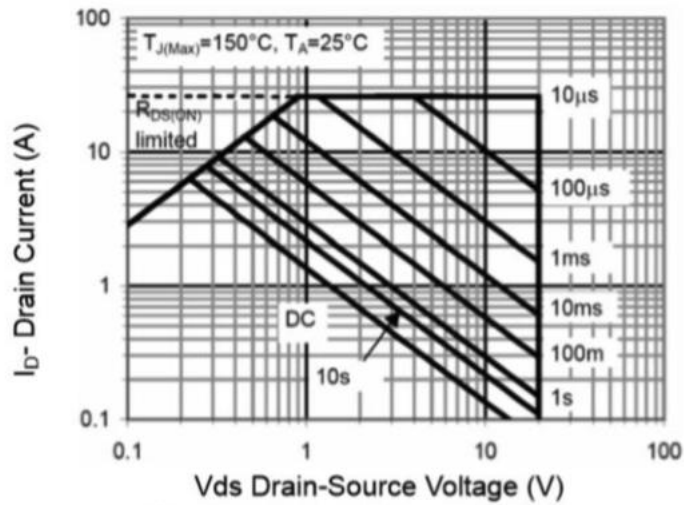

Figure 13 Safe Operation Area

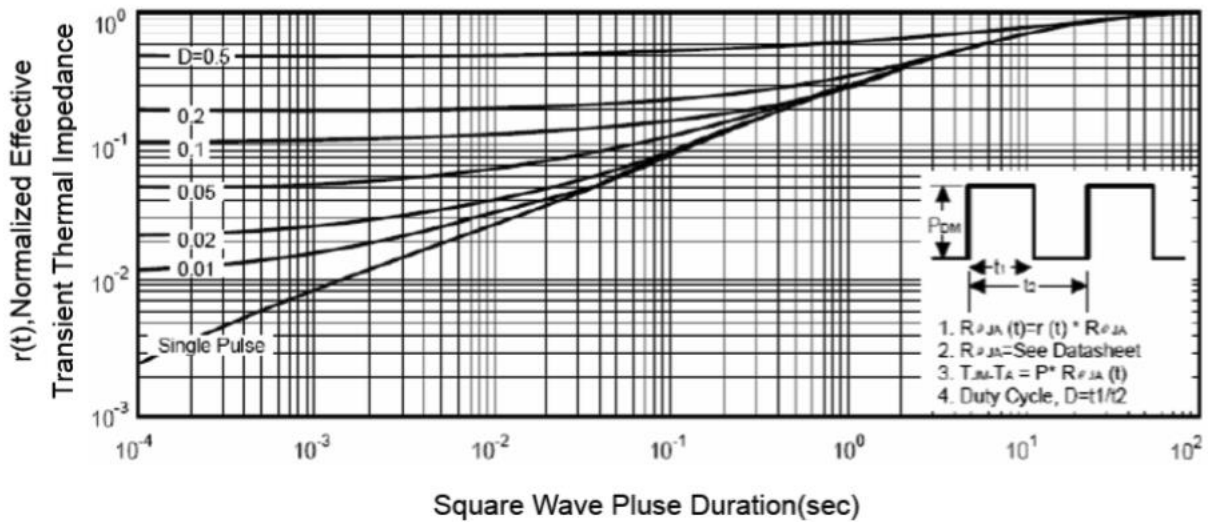
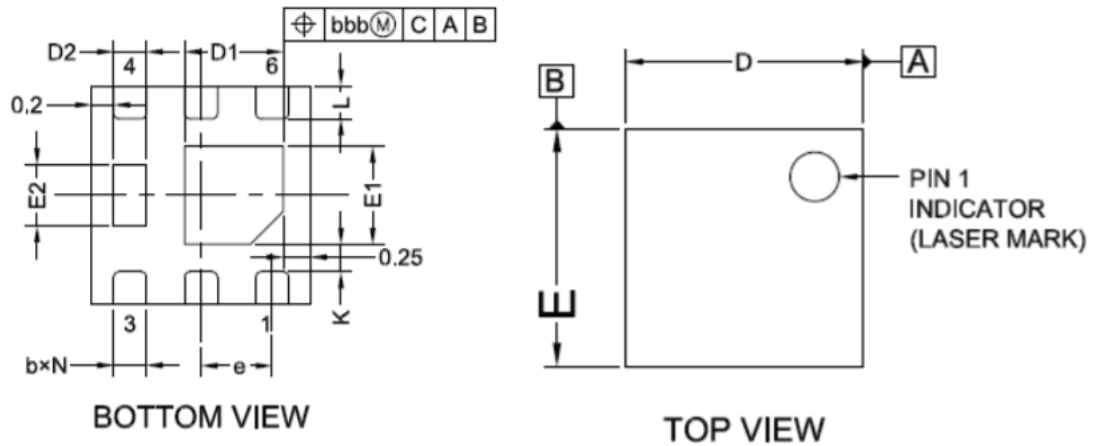

Figure 14 Normalized Maximum Transient Thermal Impedance



DFN2x2-6L 2EP PACKAGE INFORMATION



BOTTOM VIEW

TOP VIEW

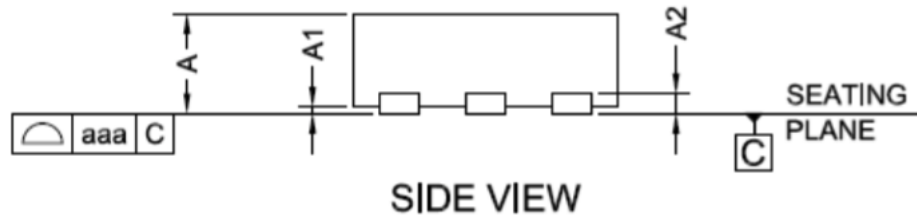

SIDE VIEW

COMMON DIMENSIONS
(UNITS OF MEASURE=MILLIMETER)

SYMBOL	MIN	TYP	MAX
A	0.50	0.55	0.60
A1	0.00	0.02	0.05
A2	0.152REF.		
b	0.25	0.30	0.35
D	1.95	2.00	2.05
D1	0.80	0.90	1.00
D2	0.25	0.30	0.35
E	1.95	2.00	2.05
E1	0.80	0.90	1.00
E2	0.46	0.56	0.66
e	0.65BSC		
L	0.25	0.30	0.35
J	0.40BSC		
K	0.20MIN		
N	6		
aaa	0.08		
bbb	0.10		