

### Description

The HSBB4115 is the high cell density trenched P-ch MOSFETs, which provide excellent RDSON and gate charge for most of the synchronous buck converter applications.

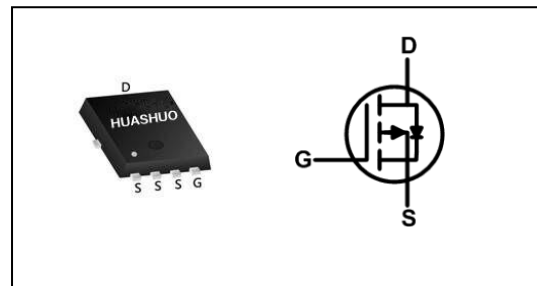
The HSBB4115 meet the RoHS and Green Product requirement, 100% EAS guaranteed with full function reliability approved.

- Super Low Gate Charge
- 100% EAS Guaranteed
- Excellent CdV/dt effect decline
- Green Device Available
- Advanced high cell density Trench technology

### Product Summary

$V_{DS}$	-40	V
$R_{DS(ON),max}$	13	m $\Omega$
$I_D$	-39	A

### PRPAK3\*3 Pin Configuration



### Absolute Maximum Ratings

Symbol	Parameter	Rating	Units
$V_{DS}$	Drain-Source Voltage	-40	V
$V_{GS}$	Gate-Source Voltage	$\pm 20$	V
$I_D@T_C=25^\circ C$	Continuous Drain Current, $V_{GS} @ -10V_1$	-39	A
$I_D@T_C=100^\circ C$	Continuous Drain Current, $V_{GS} @ -10V_1$	-24	A
$I_{DM}$	Pulsed Drain Current <sup>2</sup>	-150	A
EAS	Single Pulse Avalanche Energy <sup>3</sup>	130	mJ
$I_{AS}$	Avalanche Current	-51	A
$P_D@T_C=25^\circ C$	Total Power Dissipation <sup>4</sup>	52.1	W
$P_D@T_A=25^\circ C$	Total Power Dissipation <sup>4</sup>	1	W
$T_{STG}$	Storage Temperature Range	-55 to 150	$^\circ C$
$T_J$	Operating Junction Temperature Range	-55 to 150	$^\circ C$

### Thermal Data

Symbol	Parameter	Typ.	Max.	Unit
$R_{\theta JA}$	Thermal Resistance Junction-Ambient <sup>1</sup>	---	62	$^\circ C/W$
$R_{\theta JC}$	Thermal Resistance Junction-Case <sup>1</sup>	---	2.4	$^\circ C/W$

**Electrical Characteristics (T<sub>J</sub>=25 °C, unless otherwise noted)**

Symbol	Parameter	Conditions	Min.	Typ.	Max.	Unit
B <sub>V</sub> DSS	Drain-Source Breakdown Voltage	V <sub>GS</sub> =0V, I <sub>D</sub> =-250uA	-40	---	---	V
ΔB <sub>V</sub> DSS/ΔT <sub>J</sub>	B <sub>V</sub> DSS Temperature Coefficient	Reference to 25°C, I <sub>D</sub> =-1mA	---	-0.023	---	V/°C
R <sub>DS(ON)</sub>	Static Drain-Source On-Resistance <sup>2</sup>	V <sub>GS</sub> =-10V, I <sub>D</sub> =-18A	---	10.5	13	mΩ
		V <sub>GS</sub> =-4.5V, I <sub>D</sub> =-12A	---	15	20	
V <sub>GS(th)</sub>	Gate Threshold Voltage	V <sub>GS</sub> =V <sub>DS</sub> , I <sub>D</sub> =-250uA	-1.0	-1.6	-2.5	V
ΔV <sub>GS(th)</sub>	V <sub>GS(th)</sub> Temperature Coefficient		---	4.74	---	mV/°C
I <sub>DSS</sub>	Drain-Source Leakage Current	V <sub>DS</sub> =-32V, V <sub>GS</sub> =0V, T <sub>J</sub> =25°C	---	---	1	uA
		V <sub>DS</sub> =-32V, V <sub>GS</sub> =0V, T <sub>J</sub> =55°C	---	---	5	
I <sub>GSS</sub>	Gate-Source Leakage Current	V <sub>GS</sub> =±20V, V <sub>DS</sub> =0V	---	---	±100	nA
g <sub>fs</sub>	Forward Transconductance	V <sub>DS</sub> =-5V, I <sub>D</sub> =-18A	---	24	---	S
R <sub>g</sub>	Gate Resistance	V <sub>DS</sub> =0V, V <sub>GS</sub> =0V, f=1MHz	---	7	14	Ω
Q <sub>g</sub>	Total Gate Charge (-4.5V)	V <sub>DS</sub> =-20V, V <sub>GS</sub> =-4.5V, I <sub>D</sub> =-12A	---	27.9	---	nC
Q <sub>gs</sub>	Gate-Source Charge		---	7.7	---	
Q <sub>gd</sub>	Gate-Drain Charge		---	7.5	---	
T <sub>d(on)</sub>	Turn-On Delay Time	V <sub>DD</sub> =-15V, V <sub>GS</sub> =-10V, R <sub>G</sub> =3.3Ω, I <sub>D</sub> =-1A	---	40	---	ns
T <sub>r</sub>	Rise Time		---	35.2	---	
T <sub>d(off)</sub>	Turn-Off Delay Time		---	100	---	
T <sub>f</sub>	Fall Time		---	9.6	---	
C <sub>iss</sub>	Input Capacitance	V <sub>DS</sub> =-15V, V <sub>GS</sub> =0V, f=1MHz	---	3500	---	pF
C <sub>oss</sub>	Output Capacitance		---	323	---	
C <sub>rss</sub>	Reverse Transfer Capacitance		---	222	---	

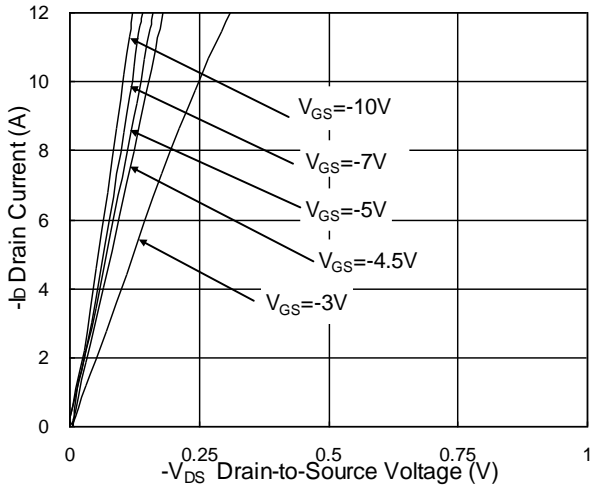
**Diode Characteristics**

Symbol	Parameter	Conditions	Min.	Typ.	Max.	Unit
I <sub>S</sub>	Continuous Source Current <sup>1,5</sup>	V <sub>G</sub> =V <sub>D</sub> =0V, Force Current	---	---	-39	A
I <sub>SM</sub>	Pulsed Source Current <sup>2,5</sup>		---	---	-77	A
V <sub>SD</sub>	Diode Forward Voltage <sup>2</sup>	V <sub>GS</sub> =0V, I <sub>S</sub> =-1A, T <sub>J</sub> =25°C	---	---	-1	V

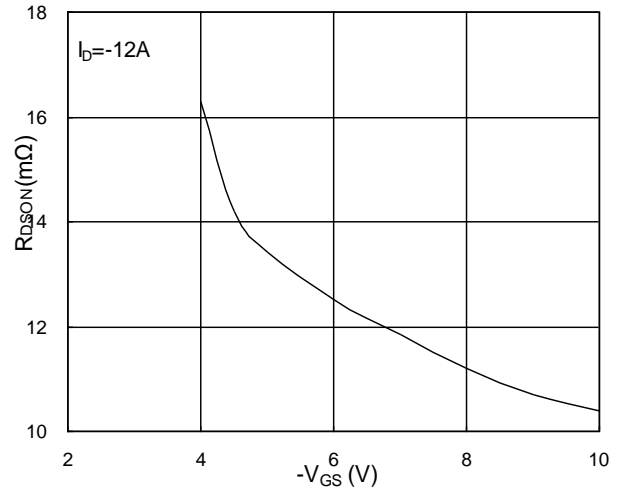
Note :

- 1.The data tested by surface mounted on a 1 inch<sup>2</sup> FR-4 board with 2OZ copper.
- 2.The data tested by pulsed, pulse width ≤ 300us, duty cycle ≤ 2%
- 3.The EAS data shows Max. rating. The test condition is V<sub>DD</sub>=-25V, V<sub>GS</sub>=-10V, L=0.1mH, I<sub>AS</sub>=-51A
- 4.The power dissipation is limited by 150°C junction temperature
- 5.The data is theoretically the same as I<sub>D</sub> and I<sub>DM</sub>, in real applications, should be limited by total power dissipation.

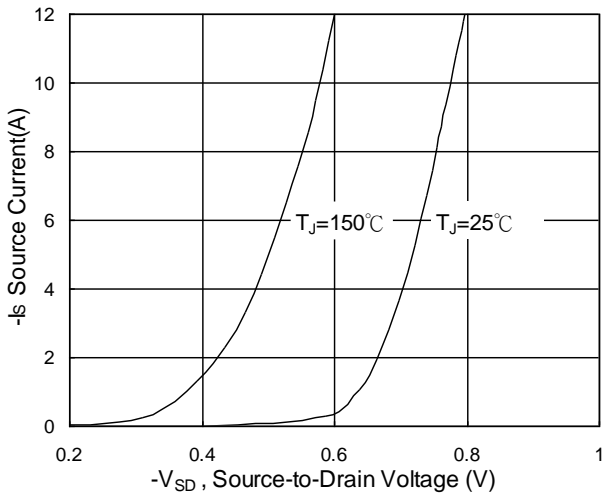
**Typical Characteristics**



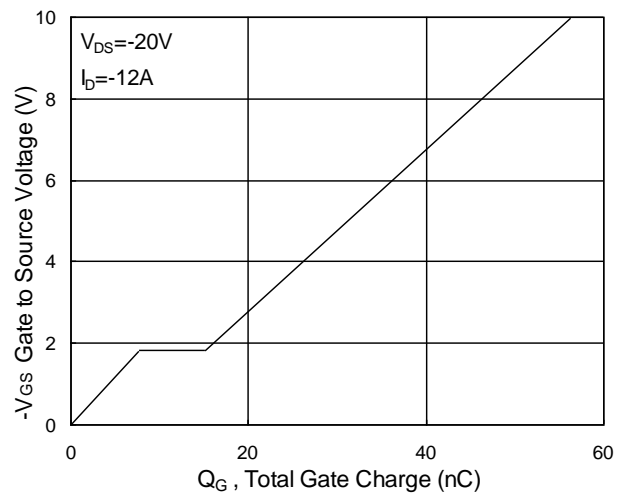
**Fig.1 Typical Output Characteristics**



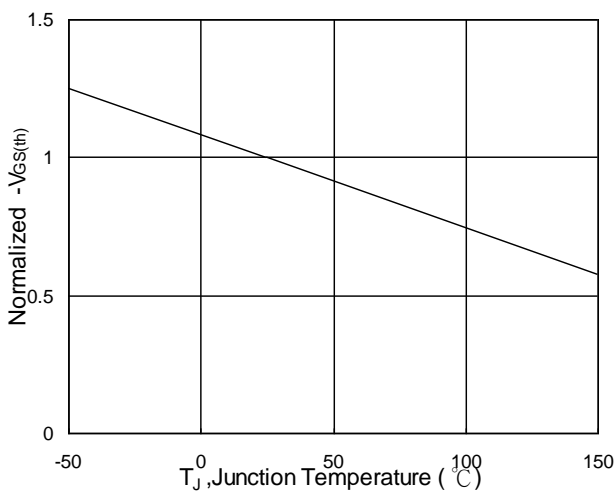
**Fig.2 On-Resistance v.s Gate-Source**



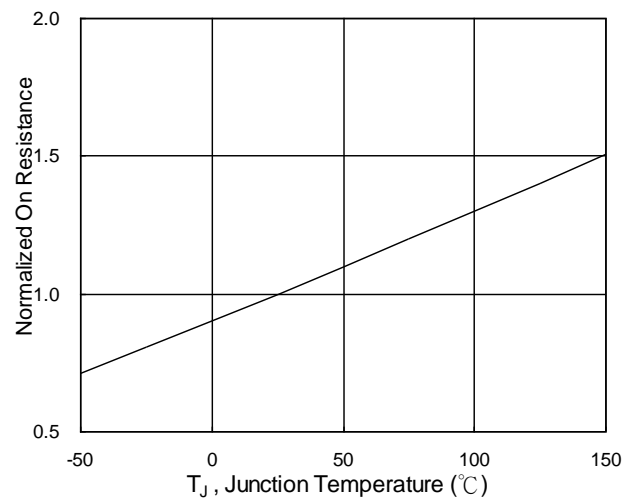
**Fig.3 Forward Characteristics Of Reverse**



**Fig.4 Gate-Charge Characteristics**

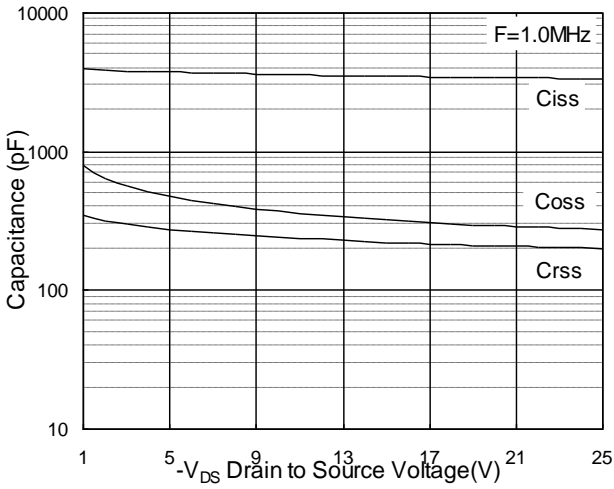


**Fig.5 Normalized  $V_{GS(th)}$  v.s  $T_J$**

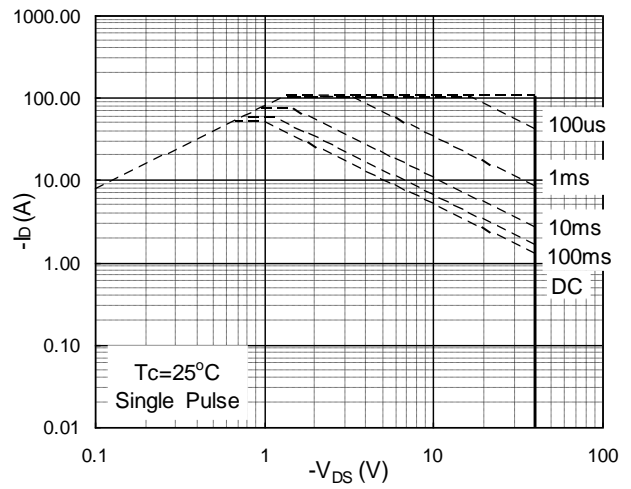


**Fig.6 Normalized  $R_{DS(on)}$  v.s  $T_J$**

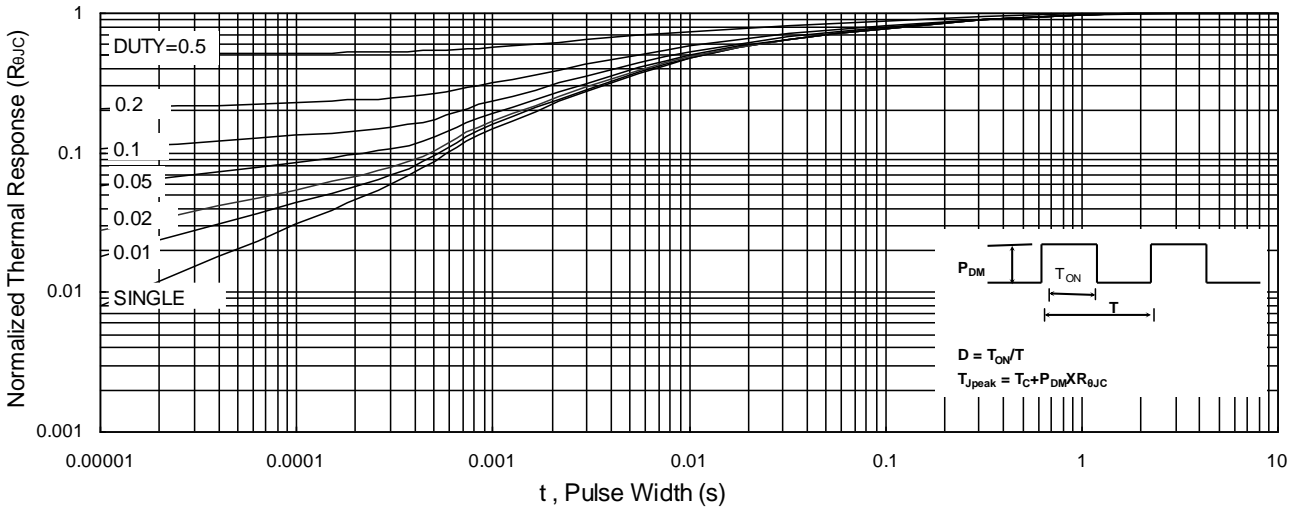
**P-Ch 40V Fast Switching MOSFETs**



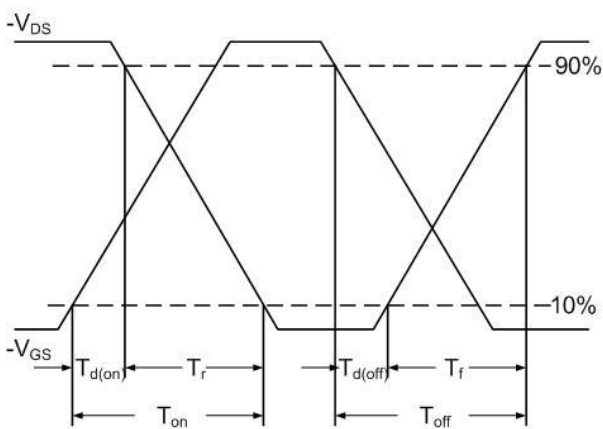
**Fig.7 Capacitance**



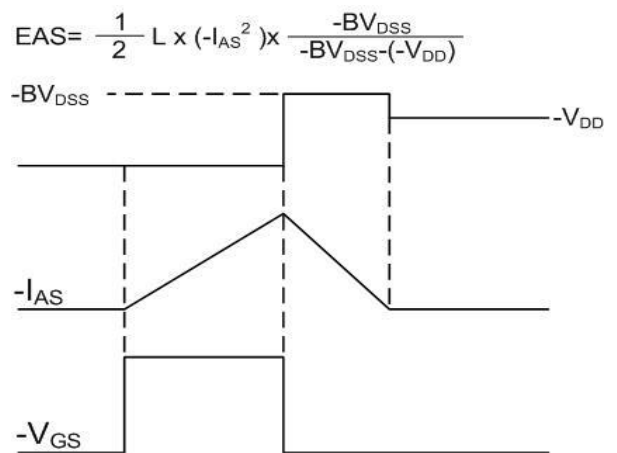
**Fig.8 Safe Operating Area**



**Fig.9 Normalized Maximum Transient Thermal Impedance**



**Fig.10 Switching Time Waveform**

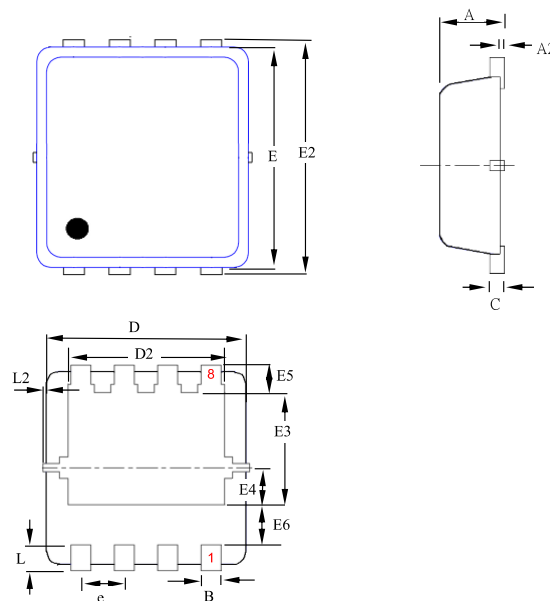


**Fig.11 Unclamped Inductive Waveform**

## Ordering Information

Part Number	Package code	Packaging
HSBB4115	PRPAK3*3	3000/Tape&Reel

**PRPAK 3\*3(E) Single Outline**



SYMBOLS	MILLIMETERS			INCHES		
	MIN	NOM	MAX	MIN	NOM	MAX
A	0.70	0.80	0.90	0.028	0.031	0.035
A2	0.00	--	0.05	0.000	--	0.002
B	0.24	0.30	0.35	0.009	0.012	0.014
C	0.10	0.15	0.25	0.004	0.006	0.010
D	2.90	3.00	3.20	0.114	0.118	0.126
D2	2.15	2.35	2.59	0.085	0.093	0.102
E	2.90	3.00	3.12	0.114	0.118	0.123
E2	3.05	3.20	3.45	0.120	0.126	0.136
E3	1.55	1.75	1.95	0.061	0.069	0.077
E4	0.48	0.58	0.68	0.019	0.023	0.027
E5	0.28	0.43	0.58	0.011	0.017	0.023
E6	0.43	0.63	0.87	0.017	0.025	0.034
L	0.30	0.40	0.50	0.012	0.016	0.020
L2	0.00	--	0.10	0.000	--	0.004
e	--	0.65	--	--	0.026	--