



### Description

The HSBA3014 is the high cell density trenched N-ch MOSFETs, which provide excellent R<sub>DS(ON)</sub> and gate charge for most of the synchronous buck converter applications.

The HSBA3014 meet the RoHS and Green Product requirement, 100% EAS guaranteed with full function reliability approved.

- 100% EAS Guaranteed
- Green Device Available
- Super Low Gate Charge
- Excellent CdV/dt effect decline
- Advanced high cell density Trench technology

### Product Summary

V <sub>DS</sub>	30	V
R <sub>DS(ON),max</sub>	12	mΩ
I <sub>D</sub>	50	A

### PRPAK5X6 Pin Configuration

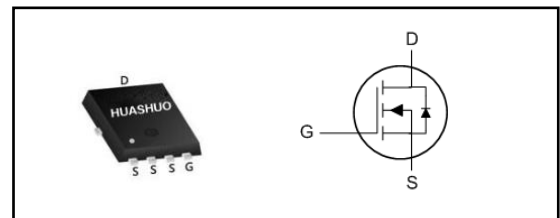

### Absolute Maximum Ratings

Symbol	Parameter	Rating	Units
V <sub>DS</sub>	Drain-Source Voltage	30	V
V <sub>GS</sub>	Gate-Source Voltage	±20	V
I <sub>D</sub> @T <sub>C</sub> =25°C	Continuous Drain Current, V <sub>GS</sub> @ 10V <sub>1</sub>	50	A
I <sub>D</sub> @T <sub>C</sub> =100°C	Continuous Drain Current, V <sub>GS</sub> @ 10V <sub>1</sub>	30	A
I <sub>D</sub> @T <sub>A</sub> =25°C	Continuous Drain Current, V <sub>GS</sub> @ 10V <sub>1</sub>	10	A
I <sub>D</sub> @T <sub>A</sub> =70°C	Continuous Drain Current, V <sub>GS</sub> @ 10V <sub>1</sub>	8	A
I <sub>DM</sub>	Pulsed Drain Current <sub>2</sub>	100	A
EAS	Single Pulse Avalanche Energy <sub>3</sub>	24.2	mJ
I <sub>AS</sub>	Avalanche Current	22	A
P <sub>D</sub> @T <sub>C</sub> =25°C	Total Power Dissipation <sub>4</sub>	41.7	W
P <sub>D</sub> @T <sub>A</sub> =25°C	Total Power Dissipation <sub>4</sub>	2	W
T <sub>STG</sub>	Storage Temperature Range	-55 to 150	°C
T <sub>J</sub>	Operating Junction Temperature Range	-55 to 150	°C

### Thermal Data

Symbol	Parameter	Typ.	Max.	Unit
R <sub>θJA</sub>	Thermal Resistance Junction-Ambient <sub>1</sub>	---	62	°C/W
R <sub>θJC</sub>	Thermal Resistance Junction-Case <sub>1</sub>	---	3	°C/W



**Electrical Characteristics (T<sub>J</sub>=25 °C, unless otherwise noted)**

Symbol	Parameter	Conditions	Min.	Typ.	Max.	Unit
BV <sub>DSS</sub>	Drain-Source Breakdown Voltage	V <sub>GS</sub> =0V, I <sub>D</sub> =250uA	30	---	---	V
ΔBV <sub>DSS</sub> /ΔT <sub>J</sub>	BVDSS Temperature Coefficient	Reference to 25°C, I <sub>D</sub> =1mA	---	0.023	---	V/°C
R <sub>DS(ON)</sub>	Static Drain-Source On-Resistance <sub>2</sub>	V <sub>GS</sub> =10V, I <sub>D</sub> =15A	---	---	12	mΩ
		V <sub>GS</sub> =4.5V, I <sub>D</sub> =10A	---	---	16.5	
V <sub>GS(th)</sub>	Gate Threshold Voltage	V <sub>GS</sub> =V <sub>DS</sub> , I <sub>D</sub> =250uA	1.0	---	2.5	V
ΔV <sub>GS(th)</sub>	V <sub>GS(th)</sub> Temperature Coefficient		---	-5.08	---	mV/°C
I <sub>DSS</sub>	Drain-Source Leakage Current	V <sub>DS</sub> =24V, V <sub>GS</sub> =0V, T <sub>J</sub> =25°C	---	---	1	uA
		V <sub>DS</sub> =24V, V <sub>GS</sub> =0V, T <sub>J</sub> =55°C	---	---	5	
I <sub>GSS</sub>	Gate-Source Leakage Current	V <sub>GS</sub> =±20V, V <sub>DS</sub> =0V	---	---	±100	nA
g <sub>fs</sub>	Forward Transconductance	V <sub>DS</sub> =5V, I <sub>D</sub> =30A	---	34	---	S
R <sub>g</sub>	Gate Resistance	V <sub>DS</sub> =0V, V <sub>GS</sub> =0V, f=1MHz	---	1.8	---	Ω
Q <sub>g</sub>	Total Gate Charge (4.5V)	V <sub>DS</sub> =15V, V <sub>GS</sub> =4.5V, I <sub>D</sub> =15A	---	9.82	---	nC
Q <sub>gs</sub>	Gate-Source Charge		---	4.2	---	
Q <sub>gd</sub>	Gate-Drain Charge		---	3.6	---	
T <sub>d(on)</sub>	Turn-On Delay Time	V <sub>DD</sub> =15V, V <sub>GS</sub> =10V, R <sub>G</sub> =3.3Ω I <sub>D</sub> =15A	---	4	---	ns
T <sub>r</sub>	Rise Time		---	8	---	
T <sub>d(off)</sub>	Turn-Off Delay Time		---	31	---	
T <sub>f</sub>	Fall Time		---	4	---	
C <sub>iss</sub>	Input Capacitance	V <sub>DS</sub> =15V, V <sub>GS</sub> =0V, f=1MHz	---	940	---	pF
C <sub>oss</sub>	Output Capacitance		---	131	---	
C <sub>rss</sub>	Reverse Transfer Capacitance		---	108	---	

**Diode Characteristics**

Symbol	Parameter	Conditions	Min.	Typ.	Max.	Unit
I <sub>S</sub>	Continuous Source Current <sub>1,5</sub>	V <sub>G</sub> =V <sub>D</sub> =0V, Force Current	---	---	50	A
I <sub>SM</sub>	Pulsed Source Current <sub>2,5</sub>		---	---	100	A
V <sub>SD</sub>	Diode Forward Voltage <sub>2</sub>	V <sub>GS</sub> =0V, I <sub>S</sub> =1A, T <sub>J</sub> =25°C	---	---	1	V
t <sub>rr</sub>	Reverse Recovery Time	I <sub>f</sub> =20A, dI/dt=100A/us, T <sub>J</sub> =25°C	---	8.5	---	nS
Q <sub>rr</sub>	Reverse Recovery Charge		---	2.2	---	nC

Note :

- 1.The data tested by surface mounted on a 1 inch<sub>2</sub> FR-4 board with 20Z copper.
- 2.The data tested by pulsed, pulse width ≤ 300us, duty cycle ≤ 2%
- 3.The EAS data shows Max. rating. The test condition is V<sub>DD</sub>=25V, V<sub>GS</sub>=10V, L=0.1mH, I<sub>AS</sub>=22A
- 4.The power dissipation is limited by 175°C junction temperature
- 5.The data is theoretically the same as I<sub>D</sub> and I<sub>DM</sub>, in real applications, should be limited by total power dissipation.



### Typical Characteristics

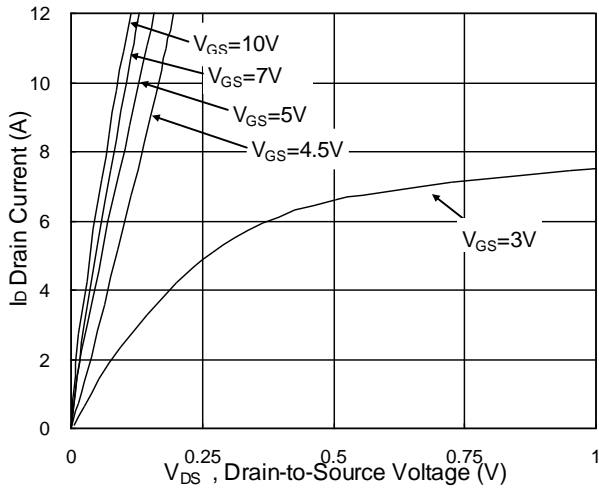

Fig.1 Typical Output Characteristics

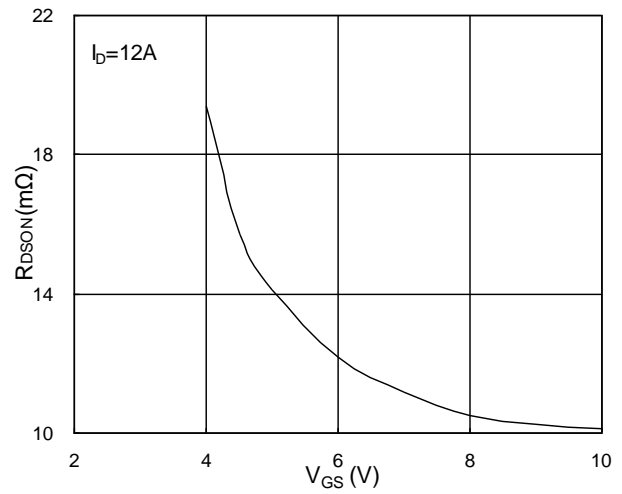

Fig.2 On-Resistance vs. G-S Voltage

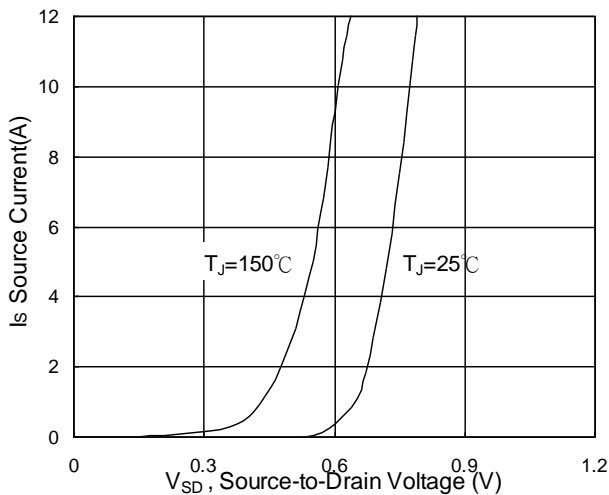

Fig.3 Forward Characteristics of Reverse

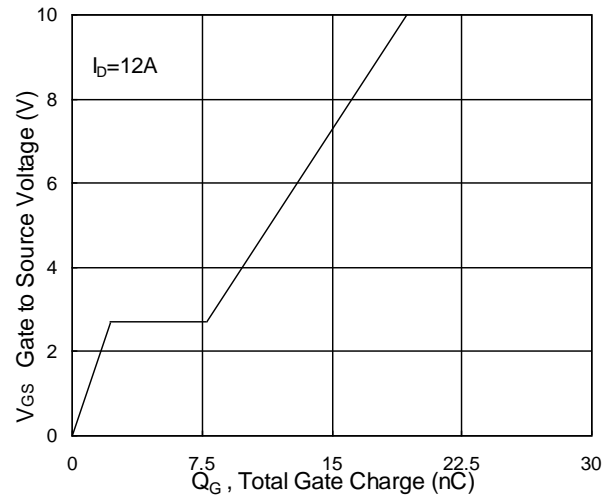

Fig.4 Gate-charge Characteristics

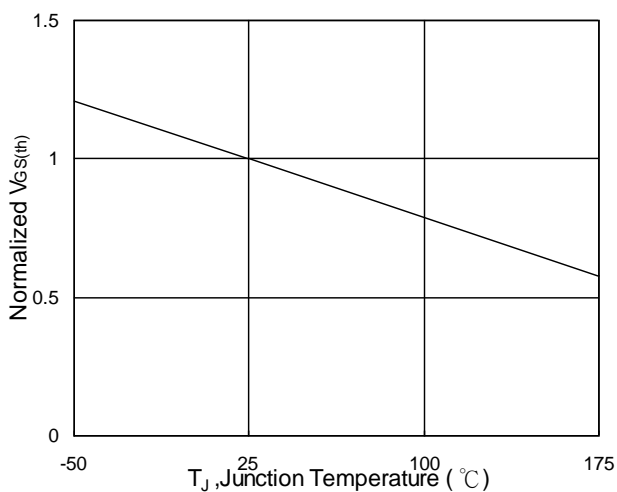

Fig.5 Normalized V<sub>GS(th)</sub> vs. T<sub>J</sub>

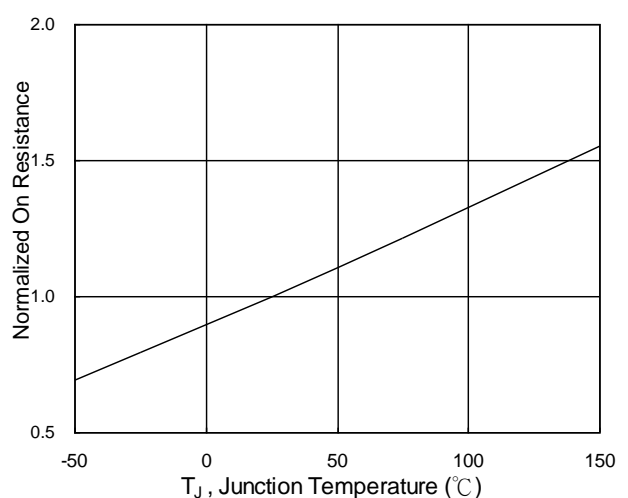
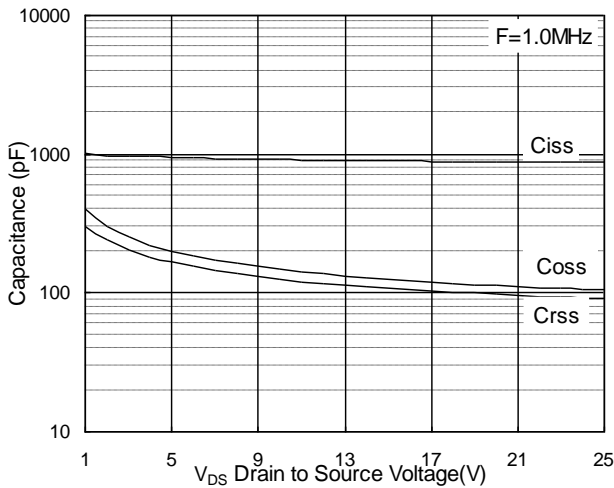
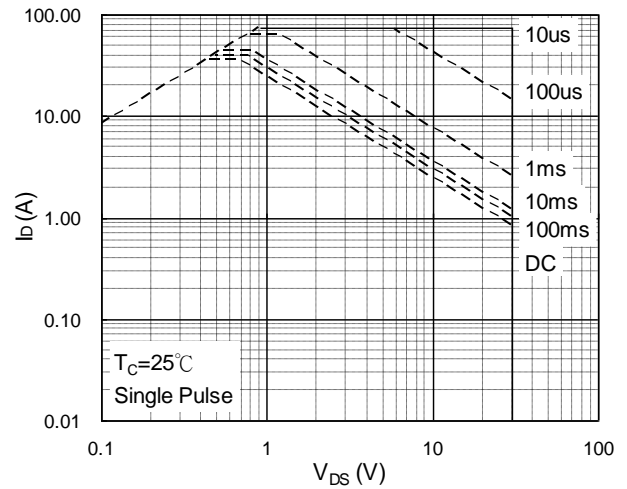

Fig.6 Normalized R<sub>DS(on)</sub> vs. T<sub>J</sub>



**Fig.7 Capacitance**



**Fig.8 Safe Operating Area**

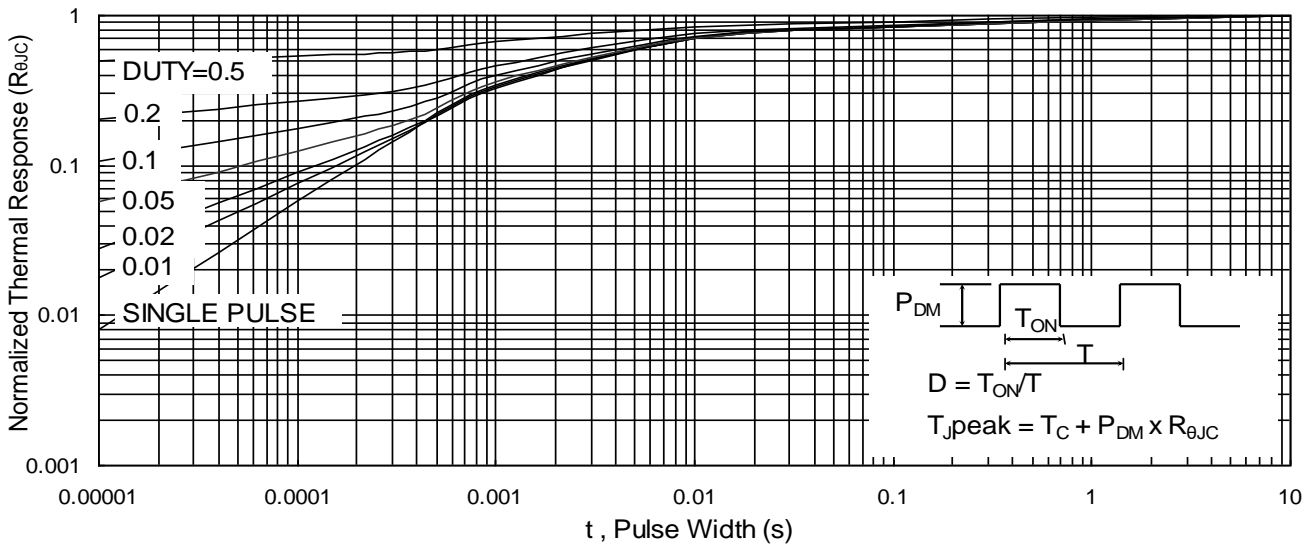

**Fig.9 Normalized Maximum Transient Thermal Impedance**

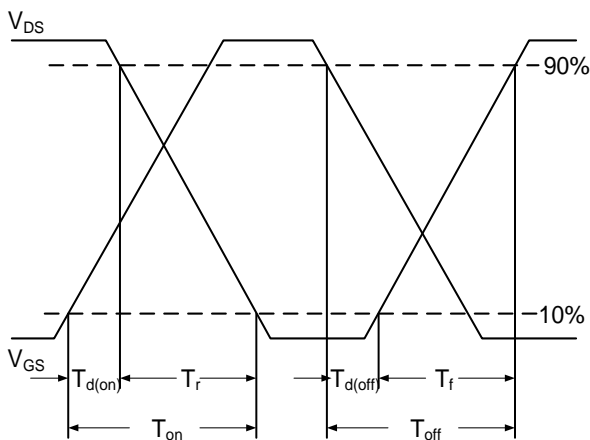

**Fig.10 Switching Time Waveform**

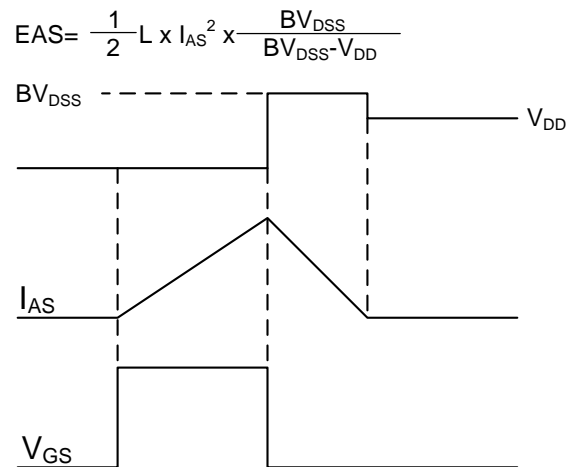

**Fig.11 Unclamped Inductive Waveform**



## Ordering Information

Part Number	Package code	Packaging
HSBA3014	PRPAK5*6	3000/Tape&Reel

PRPAK5\*6 Outline

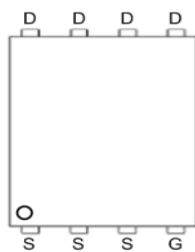
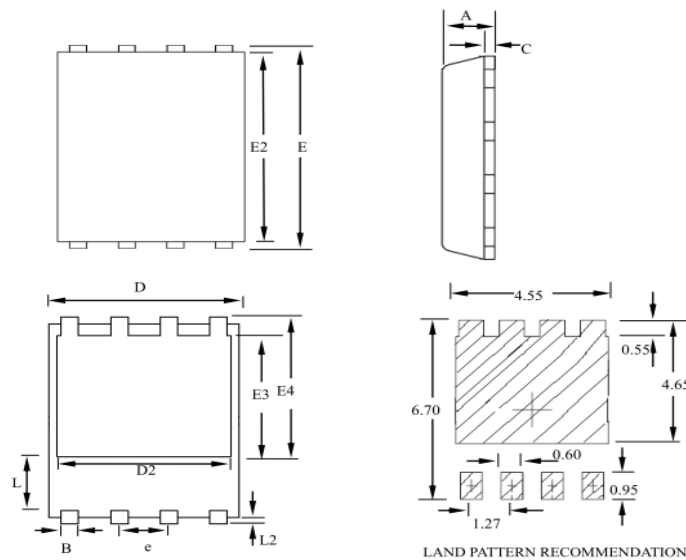

SYMBOLS	MILLIMETERS			INCHES		
	MIN	NOM	MAX	MIN	NOM	MAX
A	0.80	--	1.20	0.031	--	0.047
B	0.30	--	0.51	0.012	--	0.020
C	0.15	--	0.35	0.006	--	0.014
D	4.80	--	5.30	0.189	--	0.209
D2	3.61	--	4.35	0.142	--	0.171
E	5.90	--	6.35	0.232	--	0.250
E2	5.42	--	5.90	0.213	--	0.232
E3	3.23	--	3.90	0.127	--	0.154
E4	3.69	--	4.55	0.145	--	0.179
L	0.61	--	1.80	0.024	--	0.071
L2	0.05	--	0.36	0.002	--	0.014
e	--	1.27	--	--	0.050	--